

SF100 WSST

Conventional Sounder with Strobe

EN54-3/23

Description

SF100 WSST is a conventional wall mount sounder and strobe, designed for installing in conventional fire alarm systems. Supports 32 different tone types and two sound levels, controlled by jumpers. SF100 WSST sounder is equipped with two additional separate inputs for Alarm and Evacuation events. The tone sounds of the inputs are different for easy recognition on the protected site. The Evacuation event is with the highest priority. SF100 WSST conventional sounder is certified according EN 54-3/23.

Technical and Environmental Specifications

Operating Voltage Range	20-28VDC
Maximal consumption (main tone type 27):	
- low volume level, with enabled strobe	12mA @ 24VDC
- low volume level, no strobe	8.5mA @ 24VDC
- high volume level, with enabled strobe.	25mA @ 24VDC
- high volume level, no strobe.	22mA @ 24VDC
Sound volume (main tone type 27):	
- low volume.	87-96dB @ 1m
- high volume	95-104dB @ 1m
Frequency of the strobe flashing	1Hz
Sounder type	Piezo
Number of tone types	32
Wire Gauge for terminals	0.2-1.5mm ²
Operating temperature.	-10°C to +60°C
Relative humidity resistance	(93 ± 3)% @ 40°C
Protection.	IP21C
Weight	~248g
Dimensions	102x32mm
Color	white
Material	SAN, transparent



DoP No: 082
1293-CPR-0554
Tested by EVPU

Packing Information

- **Packing box** - 1 unit SF100 WSST, dimensions 108/108/48 mm.
- **Carton box** - 100 units SF100 WSST, dimensions 560/362/230 mm.

Compatible Product Range

- **MAG 2/4/8/8 Plus** - Conventional Fire Alarm Panels
- **SensoIRIS MOUT** - Potential output for conventional sounders
- **IRIS/SIMPO** - Addressable fire alarm panels































Contact Information:

SF100 WSST

Conventional Sounder with Strobe

EN54-3/23

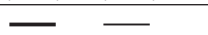
Supported Tone Types and Description

Tone	Tone Type	Tone Description / Application
1		970Hz
2		800Hz/970Hz @ 2Hz
3		800Hz - 970Hz @ 1Hz
4		970Hz 1s OFF/1s ON
5		970Hz, 0.5s/ 630Hz, 0.5s
6		554Hz, 0.1s/ 440Hz, 0.4s (AFNOR NF S 32 001)
7		500 - 1200Hz, 3.5s/ 0.5s OFF (NEN 2575:2000)
8		420Hz 0.625s ON/0.625s OFF (Australia AS1670 Alert tone)
9		500 - 1200Hz, 0.5s/ 0.5s OFF x 3/1.5s OFF (AS1670 Evacuation)
10		550Hz/440Hz @ 0.5Hz
11		970Hz, 0.5s ON/0.5s OFF x 3/ 1.5s OFF (ISO 8201)
12		2850Hz, 0.5s ON/0.5s OFF x 3/1.5s OFF (ISO 8201)
13		1200Hz - 500Hz @ 1Hz (DIN 33 404)
14		400Hz
15		550Hz, 0.7s/1000Hz, 0.33s
16		1500Hz - 2700Hz @ 3Hz
17		750Hz
18		2400Hz
19		660Hz
20		660Hz 1.8s ON/1.8s OFF
21		660Hz 0.15s ON/0.15s OFF
22		510Hz, 0.25s/ 610Hz, 0.25s
23		800/1000Hz 0.5s each (1Hz)
24		250Hz - 1200Hz @ 12Hz
25		500Hz - 1200Hz @ 0.33Hz
26		2400Hz - 2900Hz @ 9Hz
27		2400Hz - 2900Hz @ 3Hz (2500Hz main sound frequency)
28		800Hz - 970Hz @ 100Hz
29		800Hz - 970Hz @ 9Hz
30		800Hz - 970Hz @ 3Hz
31		800Hz, 0.25s ON/1s OFF
32		500Hz - 1200Hz, 3.75s/0.25s OFF (AS2220)

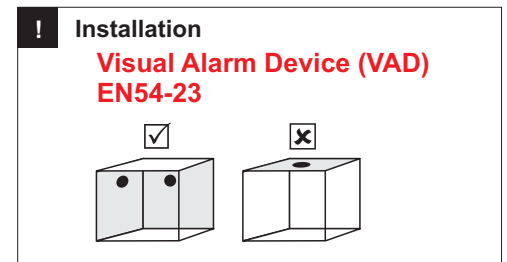
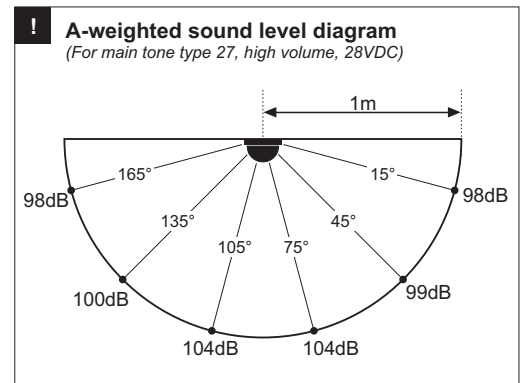

Contact Information: