

# Satel®

## INT-SCR

**Multifunctional keypad  
with proximity card reader**

CE



Firmware version 2.03

int-scr\_en 08/20

SATEL sp. z o.o. • ul. Budowlanych 66 • 80-298 Gdańsk • POLAND  
tel. +48 58 320 94 00  
[www.satel.eu](http://www.satel.eu)

## IMPORTANT

The device should be installed by qualified personnel.

Prior to installation, please read carefully this manual.

Changes, modifications or repairs not authorized by the manufacturer shall void your rights under the warranty.

SATEL aims to continually improve the quality of its products, which may result in changes in their technical specifications and software. Current information about the changes being introduced is available on our website.

Please visit us at:

<http://www.satel.eu>

**The declaration of conformity may be consulted at [www.satel.eu/ce](http://www.satel.eu/ce)**

The following symbols may be used in this manual:



- note,



- caution.

## CONTENTS

1. Features .....	2
2. Description.....	3
Operating modes.....	3
LED indicators.....	3
Bell key.....	3
Wires.....	4
3. Installation .....	4
3.1 Address setting and operating mode selection.....	6
Address setting .....	6
Operating mode selection .....	6
4. Configuring the keypad.....	7
4.1 Description of parameters and options.....	7
Partition keypad with proximity card reader (INT-SCR).....	7
Entry keypad (INT-ENT).....	11
Partition keypad (INT-S/SK).....	12
5. Using the keypad.....	15
5.1 Partition keypad with proximity card reader (INT-SCR).....	15
LED indicators.....	15
Sound signaling.....	16
Available functions .....	16
Impact of the EN 50131 standard on keypad use .....	18
5.2 Entry keypad (INT-ENT).....	18
LED indicators.....	18
Sound signaling.....	18
Available functions .....	19
5.3 Partition keypad (INT-S/SK).....	19
6. Specifications .....	19

The INT-SCR multifunctional keypad with proximity card reader is compatible with the INTEGRA and INTEGRA Plus alarm control panels. It can work as:

- **partition keypad with proximity card reader** – identified in the alarm system as INT-SCR. It allows the user to control one partition of the alarm system. The device makes it possible to manage access to a single door. The user can use the access code or the proximity card (i.e. a 125 kHz passive transponder in the form of a card, tag, etc.).
- **entry keypad** – identified in the alarm system as INT-ENT. It allows the user to activate delay for the “3. Interior delayed” type zones in the partition controlled with the keypad. The user can use the access code or the proximity card (i.e. a 125 kHz passive transponder in the form of a card, tag, etc.).
- **partition keypad** – identified in the alarm system as INT-S/SK. It provides the same features as the partition keypad with proximity card reader, but the user can only use the access code.

The keypad is designed for both indoor and outdoor installation.

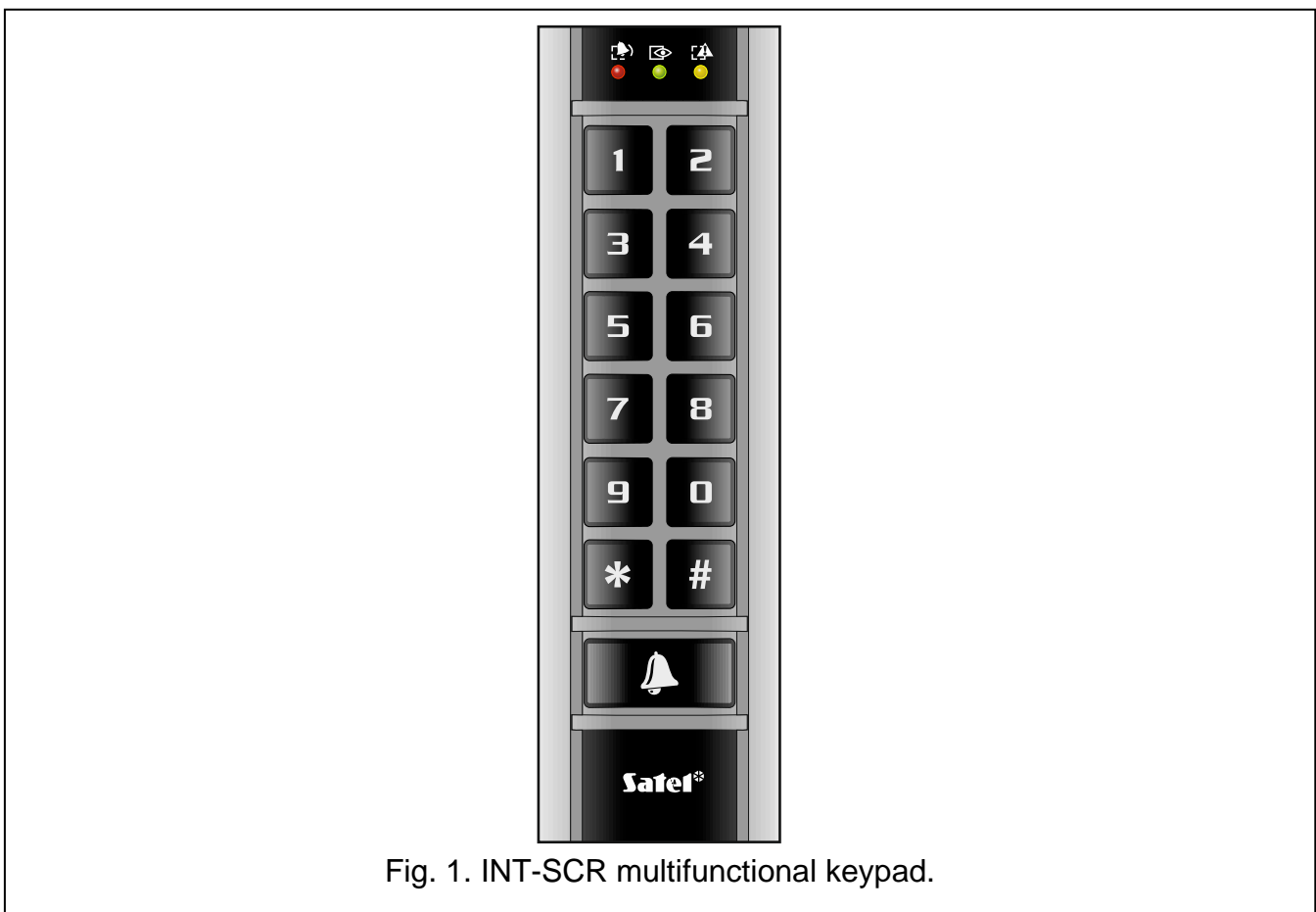

## 1. Features

---

- LED indicators.
- 12 keys used to operate the alarm system.
- Bell key.
- Backlit keys.
- Built-in proximity card reader.
- OC type output controlled directly from the keypad (BELL).
- Relay output for control of electric strike, electromagnetic lock or another door actuator.

- Door status input.
- Built-in sounder.
- Tamper protection against enclosure opening and removal from the wall.

## 2. Description

---

### Operating modes

You can select the keypad operating mode (see “Address setting and operating mode selection”). The operating mode defines which features are available.

#### ***Partition keypad with proximity card reader (INT-SCR)***

- Ability to use cards, tags and other 125 kHz passive transponders to control the alarm system.
- Arming / disarming and alarm clearing in partition.
- Capability of triggering alarm from the keypad.
- Single door control.
- Control of “24. MONO switch” and “25. BI switch” type outputs.
- The ability to change access code by the user.

#### ***Entry keypad (INT-ENT)***

- Ability to use cards, tags and other 125 kHz passive transponders to control the alarm system.
- Activation of the delay for the “3. Interior delayed” type zones in the partition.
- Control of “24. MONO switch” and “25. BI switch” type outputs.

#### ***Partition keypad (INT-S/SK)***

- Arming / disarming and alarm clearing in partition.
- Capability of triggering alarm from the keypad.
- Single door control.
- Control of “24. MONO switch” and “25. BI switch” type outputs.
- The ability to change access code by the user.

### LED indicators

The keypad has 3 LEDs:



- red,



- green,



- yellow.

What information is presented by the LEDs depends on the operating mode (see “Using the keypad”).

### Bell key

The bell key controls directly the BELL output of the keypad. The BELL output is an OC type low-current output. Pressing the key will short the output to the common ground.

## Wires

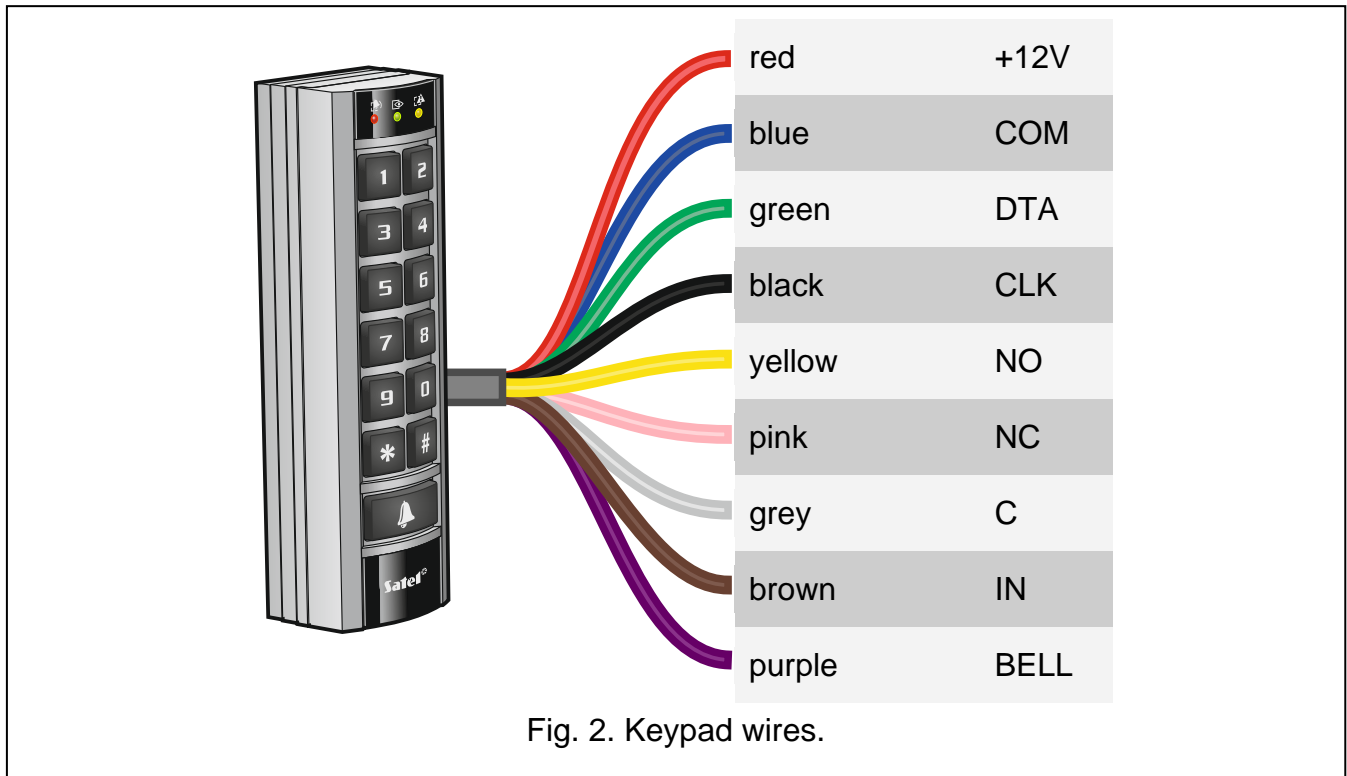

Color	Description	
red	+12V	+12 VDC power input
blue	COM	common ground
green	DTA	data
black	CLK	clock
yellow	NO	relay output normally open contact
pink	NC	relay output normally closed contact
grey	C	relay output common contact
brown	IN	door status input (NC type)
purple	BELL	OC type output

## 3. Installation



**Disconnect power before making any electrical connections.**

If the reader cable is too short, you can use an unshielded non-twisted cable to extend it. If you use the twisted-pair type of cable, remember that CLK (clock) and DTA (data) signals must not be sent through one twisted pair. The wires must be run in one cable.



*If the keypad is installed on a metal surface, the card reading range will be reduced.*

*The distance from an another device with built-in proximity card reader (e.g. a keypad with reader) should be at least 50 centimeters.*

1. Open the keypad enclosure.
2. Place the enclosure base on the wall and mark the location of mounting holes.
3. Drill the holes for wall plugs (anchors).
4. Using wall plugs (anchors) and screws, secure the enclosure base to the wall. Select wall plugs specifically intended for the mounting surface (different for concrete or brick wall, different for plaster wall, etc.).
5. Close the enclosure and secure it with the screw.
6. Connect the blue (COM), green (DTA) and black (CLK) wires to the appropriate terminals of the control panel expander bus (see the control panel installer manual).

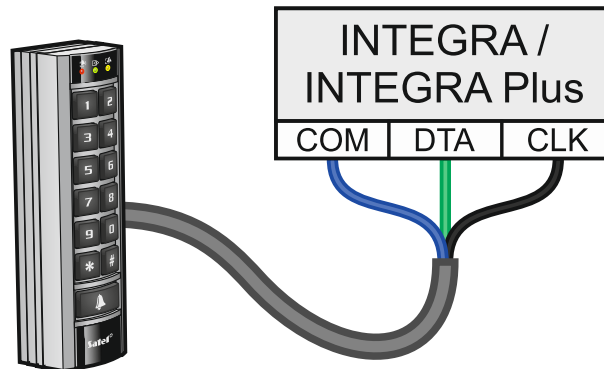

Fig. 3. Connecting the keypad to the control panel.

7. If the keypad is to control an electric strike, electromagnetic lock or another door actuator, connect this device to the relay output as shown in Fig. 4. Depending on the device type, use the following wires:
  - NC – pink (NC contact of the relay) and gray (C contact of the relay),
  - NO – yellow (NO contact of the relay) and gray (C contact of the relay).

It is not recommended that the door actuator be powered from the same source as the keypad.



*In the entry keypad mode, the relay output is disabled (you cannot control the actuator).*

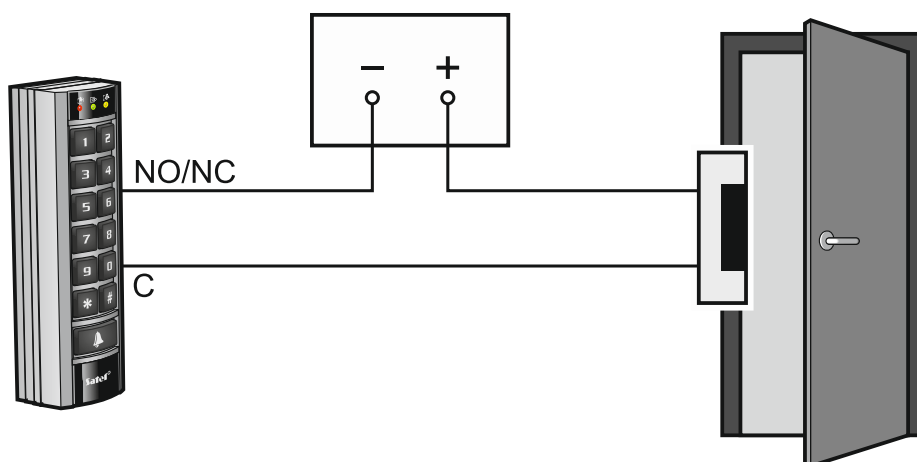

Fig. 4. Connecting the actuator to the keypad.

8. If the keypad is to supervise the door status, connect the detector supervising the door status to the brown wire (door status input) and the blue wire (COM). If the keypad is not

to supervise the door status, connect the brown and blue wires together or, when configuring the keypad, set value 0 for the “Max. door open time” parameter.





*The door status input is not supported in the entry keypad mode.*

9. Connect the power to the red (+12V) and blue (COM) wires. The keypad may be powered directly from the control panel, from an expander with power supply or from a power supply unit.
10. The purple wire (BELL output) you can connect e.g. to the one of the control panel zones.
11. Set the address and select the operating mode for the keypad (see “Address setting and operating mode selection”).
12. Power on the keypad.
13. Start the identification function in the control panel (see the control panel installer manual). How the keypad will be identified depends on selected operating mode.



### 3.1 Address setting and operating mode selection

---

The keypad with factory default settings has address 0 and its operating mode is “partition keypad with proximity card reader”. If you wish to change its address or select another operating mode, follow the procedure below.

1. Power off the keypad (if it is powered on).
2. Disconnect the green (DTA) and black (CLK) wires from the terminals of the control panel expander bus.
3. Short the green and black wires.
4. Power on the keypad.
5. The  and  LEDs will start flashing alternately (then, you can disconnect the green and black wires).
6. Set the address or select the operating mode.



#### Address setting

1. Press in turn **1** and **#**.
2. The  LED will start flashing.
3. Use the numeric keys to enter a new address from the range of 0 to 31.
4. Press **#**.
5. The  and  LEDs will start flashing alternately. You can proceed to select the operating mode (press **2** and **#** in turn) or end the procedure (turn power off and connect the green (DTA) and black (CLK) wires to the corresponding terminals of the control panel expander bus).

#### Operating mode selection

1. Press in turn **2** and **#**.
2. The  LED will start flashing.
3. Select the operating mode by pressing one of the keys:
  - 1** - partition keypad with proximity card reader (INT-SCR),
  - 2** - entry keypad (INT-ENT),
  - 3** - partition keypad (INT-S/SK).
4. Press **#**.



5. The  and  LEDs will start flashing alternately. You can go on to set the address (press **1** and **#** in turn) or end the procedure (turn power off and connect the green (DTA) and black (CLK) wires to the corresponding terminals of the control panel expander bus).

## 4. Configuring the keypad

---

The keypad settings you can configure using:

- DLOADX program: →“Structure” window →“Hardware” tab →“Expansion modules” branch →*[keypad name]*,
- LCD keypad: ►“Service mode” ►“Structure” ►“Hardware” ►“Expanders” ►“Settings” ►*[keypad name]*.

### 4.1 Description of parameters and options

---

Depending on the operating mode, a different set of parameters and options is available. Names of parameters and options from the DLOADX program are used in this manual. Shown in square brackets at the description of a parameter or option is the name presented on the display of the LCD keypad.

#### Partition keypad with proximity card reader (INT-SCR)

**Name** – individual name of the device (up to 16 characters).

**Partition** – partition operated by the keypad.

**Lock** [Lock feature] – if the option is enabled, the keypad can control access to a single door (the following parameters are available: “Lock features”, “Relay ON time”, “Max. door open time” etc.).

**Lock features** [Lock function] – mode of operation of the relay output after the access is granted:

**ON if partition armed** [On if part.armed] – the relay output will be turned on until the partition is armed. When the partition is armed, users cannot get access (to get access, the user must disarm the partition).

**Fixed ON time** [ON time] – the relay output will be turned on for the “Relay ON time”.

**Fixed ON time – OFF if door open** [ON, open→off] – the relay output will be turned on until the door is opened (door status input is disconnected from common ground), however not longer than for the “Relay ON time”.

**Fixed ON time – OFF if door closed** [ON, close→off] – the relay output will be turned on until the door is closed (door status input is reconnected to common ground), however not longer than for the “Relay ON time”.

**Relay ON time** – the time during which the relay output can be turned on after the access is granted. You can program from 1 to 255 seconds. The parameter does not apply to the “ON if partition armed” mode.

**Authorization control** [Unauth. event] – if this option is enabled, unauthorized opening of the door will save the event to the control panel memory.

**Alarm on unauth. access** [Unauth. alarm] – if this option is enabled, unauthorized opening of the door when the partition is armed will trigger an alarm. The option is available if the “Authorization control” option is enabled.

**Max. door open time** [Max. door open] – the maximum period of time during which the door can be open (the door status input can be disconnected from common ground). If the door is open longer, audible alarm will be triggered in the keypad, and the event will be saved to

the control panel memory. You can enter from the 0 to 255 seconds. If you enter 0, the door can be open for any long period of time.

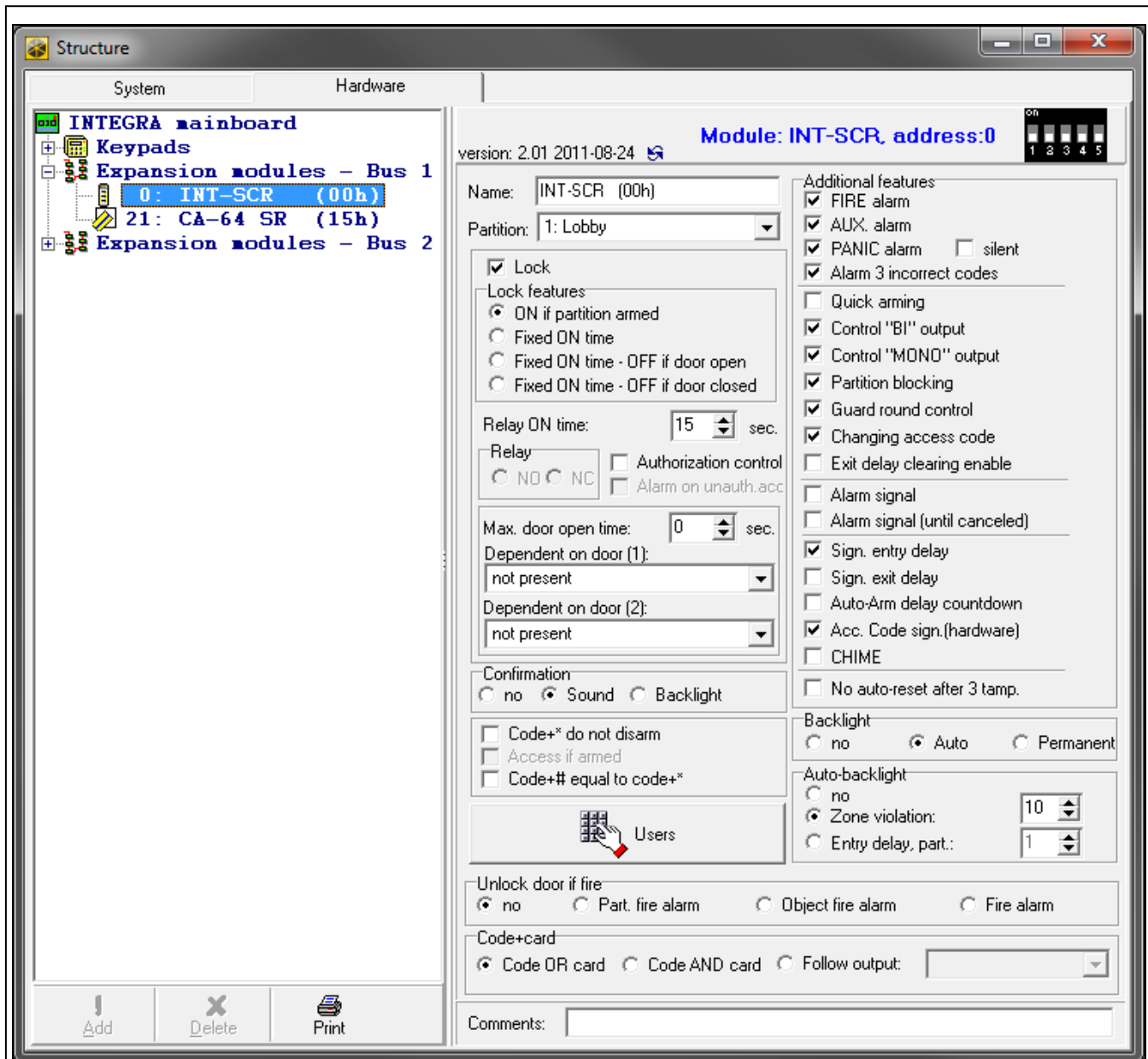

Fig. 5. DLOADX program: settings of partition keypad with proximity card reader (INT-SCR).

**Dependent on door (1) / Dependent on door (2)** – you can select the door that must be closed so that the user can get access (turn the relay output on). It allows you to create an airlock. You may select a door supervised by another expander or alarm system zone programmed as type “57 Technical – door open”.

**Confirmation** – method of providing feedback to the user after using the keypad:

**No** – no feedback.

**Sound** – the keypad will use sounds to give feedback to the user.

**Backlight** – the keypad will use key backlight to give feedback to the user.

**Code+\* do not disarm** [Code\* not dis.] – if this option is enabled, entering the code and pressing **\*** / presenting the card will not disarm the partition (to disarm the partition, the user must enter the code and press **#** / hold the card).

**Access if armed** [Code\* in arm] – if the option is enabled, the users can gain access (turn the relay output on) when the partition is armed. If the option is disabled, the users cannot

gain access when the partition is armed. The option is available, if the “Code+\* do not disarm” option is enabled. The option does not apply to the “ON if partition armed” mode.

**Code+# equal to code+\*** [Code#->Code\*] – if the option is enabled, reaction to entering the code and pressing **#** / holding the card is the same as to entering the code and pressing **\*** / presenting the card. This means that the functions normally available on entering the code and pressing **#** / holding the card (e.g. arming the partition) are not available. The option is available when the “Lock” option is enabled.

**Users** [Master users / Users] – the administrators and users which are permitted to use the keypad.

**FIRE alarm** – if this option is enabled, pressing and holding **#** for 3 seconds will trigger the fire alarm.

**AUX. alarm** [Medical alarm] – if this option is enabled, pressing and holding **0** for 3 seconds will trigger the medical alarm.

**PANIC alarm** – if this option is enabled, pressing and holding **\*** for 3 seconds will trigger the panic alarm.

**silent** [Silent panic] – if this option is enabled, the panic alarm triggered from the keypad will be a silent one, i.e. the keypad will not indicate it, there will be no audible signal, but the alarm will be reported to the monitoring station. The silent panic alarm is useful when the control panel is sending events to the monitoring station, but unauthorized persons should not be aware of the alarm being triggered. This option is available, if the “PANIC alarm” option is enabled.

**Alarm 3 incorrect codes** [3 wrong codes] – if this option is enabled, using an incorrect code / card three times will trigger an alarm.

**Quick arming** [Quick arm] – if the option is enabled, the user needs no code / card to arm the partition using the keypad.

**Control “BI” output** [BI outs ctrl.] – if this option is enabled, the ““Bi” output operating” type of users can use the keypad to control outputs.

**Control “MONO” output** [MONO outs ctr.] – if this option is enabled, the ““Mono” output operating” type of users can use the keypad to control outputs.

**Partition blocking** [Part.blocking] – if the option is enabled, using the code / card by a user of the “Blocking partition” or “Guard” type will block the armed partition (violating a zone belonging to the partition will trigger no alarm). The duration of blocking is to be defined for the partition or the user (the user of “Blocking partition” type).

**Guard round control** [Guard control] – if this option is enabled, using the code / card by a user of the “Guard” type will be registered as the guard round.

**Changing access code** [Changing code] – if this option is enabled, the user can change own code from the keypad.

**Exit delay clearing enable** [Fin.exit time] – if the option is enabled, the user can terminate the partition exit delay countdown by pressing successively **9** and **#** (if the “Exit delay clearing” option is enabled for the partition).

**Alarm signal** [Alarm (time)] – if this option is enabled, the keypad will audibly signal alarms throughout the “Global alarm time” (parameter programmed in the control panel).

**Alarm signal (until canceled)** [Alarm (latch)] – if this option is enabled, the keypad will audibly signal alarms until they are cleared.

**Sign. entry delay** [Entry time] – if this option is enabled, the keypad will audibly signal the entry delay countdown.

**Sign. exit delay** [Exit time] – if this option is enabled, the keypad will audibly signal the exit delay countdown.

**Auto-Arm delay countdown** [Auto-arm delay] – if this option is enabled, the keypad will audibly signal the auto-arm delay countdown.

**Acc. code sign. (hardware)** [Code entered] – if this option is enabled, the keypad will confirm with a single beep that the code is entered / card is presented (signaling independent of the control panel). The signaling is useful when there is a delay between entering the code / presenting the card and the sounds emitted after verification of the code / card by the control panel.

**CHIME** [Chime zones] – if this option is enabled, the keypad will audibly signal violation of zones with “Chime in module” option enabled, belonging to the partition operated by means of the keypad.

**No auto-reset after 3 tamp.** [No autorst.3t.] – if this option is enabled, the feature reducing the number of tamper alarms from the module to three is disabled (the feature prevents multiple logging of the same events and applies to successive uncleared alarms).

**Backlight** – the way how the keys backlight works:

**No** – always off.

**Auto** – on for about 40 seconds after pressing any key / reading a card. Additionally, it can be turned on if a specific event occurs (see the “Auto-backlight” parameter).

**Permanent** – always on.

**Auto-backlight** – if the keys backlight goes on automatically, you can define whether and what event will additionally turn on the backlight:

**No** – the keys backlight will not be additionally turned on.

**Zone violation** – the keys backlight will additionally go on if a selected zone is violated.

**Entry delay, part.** – the keys backlight will additionally go on if entry delay countdown starts in the selected partition.

**Unlock door if fire** [Doors on fire] – you can define whether and when the fire alarm will unlock the door controlled by the keypad (i.e. will activate the relay output):

**No** [no open] – the door will not be unlocked in the event of fire alarm.

**Part. fire alarm** [on partit. fire] – the door will be unlocked in the event of fire alarm in the partition to which the keypad is assigned.

**Object fire alarm** [on object fire] – the door will be unlocked in the event of fire alarm in the object to which the keypad is assigned.

**Fire alarm** [on any fire] – the door will be unlocked in the event of fire alarm in the alarm system.

**Code+card** – how functions are to be started by the users (e.g. arming / disarming, alarm clearing, getting access, etc.).

**Code OR card** – using the code or the card.

**Code AND card** – using the code and the card.

**Follow output** – depending on the selected output state (output OFF – using the code or the card; output ON – using the code and the card).

## Entry keypad (INT-ENT)

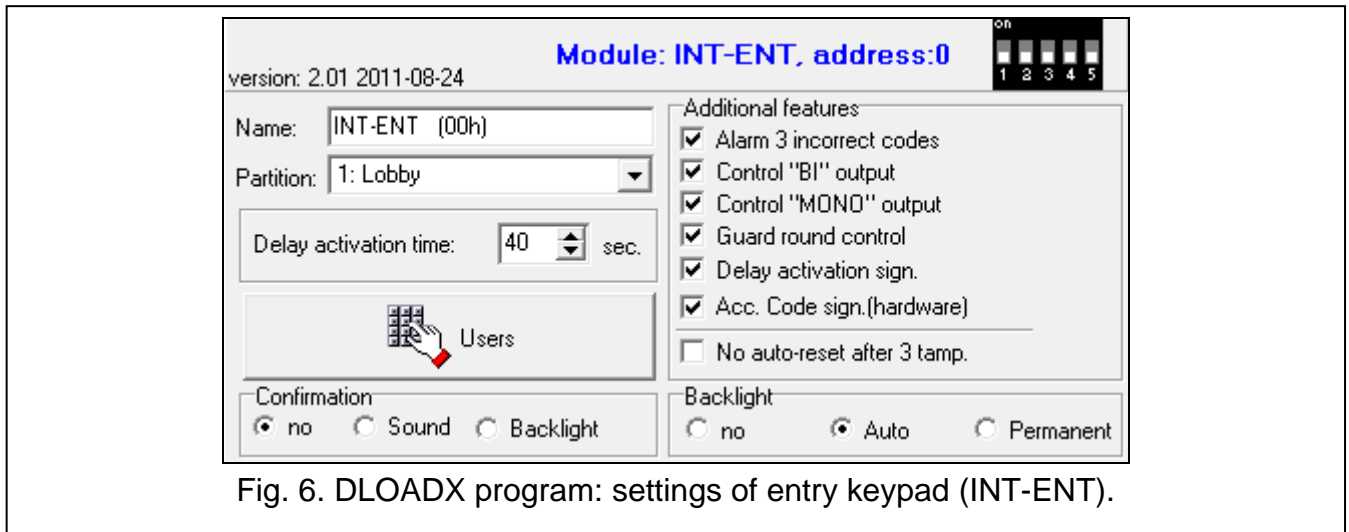

Fig. 6. DLOADX program: settings of entry keypad (INT-ENT).

**Name** – individual name of the device (up to 16 characters).

**Partition** – partition operated by the keypad.

**Delay activation time** [Delay act. time] – the time counted from using the code / card, during which the “3. Interior delayed” type zones operate as delayed ones (in the partition operated by keypad).

**Users** [Master users / Users] – the administrators and users which are permitted to use the keypad.

**Confirmation** – method of providing feedback to the user after using the keypad:

**No** – no feedback.

**Sound** – the keypad will use sounds to give feedback to the user.

**Backlight** – the keypad will use key backlight to give feedback to the user.

**Alarm 3 incorrect codes** [3 wrong codes] – if this option is enabled, using an incorrect code / card three times will trigger an alarm.

**Control “BI” output** [BI outs ctrl.] – if this option is enabled, the ““Bi” output operating” type of users can use the keypad to control outputs.

**Control “MONO” output** [MONO outs ctr.] – if this option is enabled, the ““Mono” output operating” type of users can use the keypad to control outputs.

**Guard round control** [Guard control] – if this option is enabled, using the code / card by a user of the “Guard” type will be registered as the guard round.

**Delay activation sign.** [Delay act. time] – if this option is enabled, the keypad will audibly signal the countdown of delay activation time.

**Acc. code sign. (hardware)** [Code entered] – if this option is enabled, the keypad will confirm with a single beep that the code is entered / card is presented (signaling independent of the control panel). The signaling is useful when there is a delay between entering the code / presenting the card and the sounds emitted after verification of the code / card by the control panel.

**No auto-reset after 3 tamp.** [No autorst.3t.] – if this option is enabled, the feature reducing the number of tamper alarms from the module to three is disabled (the feature prevents multiple logging of the same events and applies to successive uncleared alarms).

**Backlight** – the way how the keys backlight works:

**No** – always off.

**Auto** – on for about 40 seconds after pressing any key / reading a card.

**Permanent** – always on.

## Partition keypad (INT-S/SK)

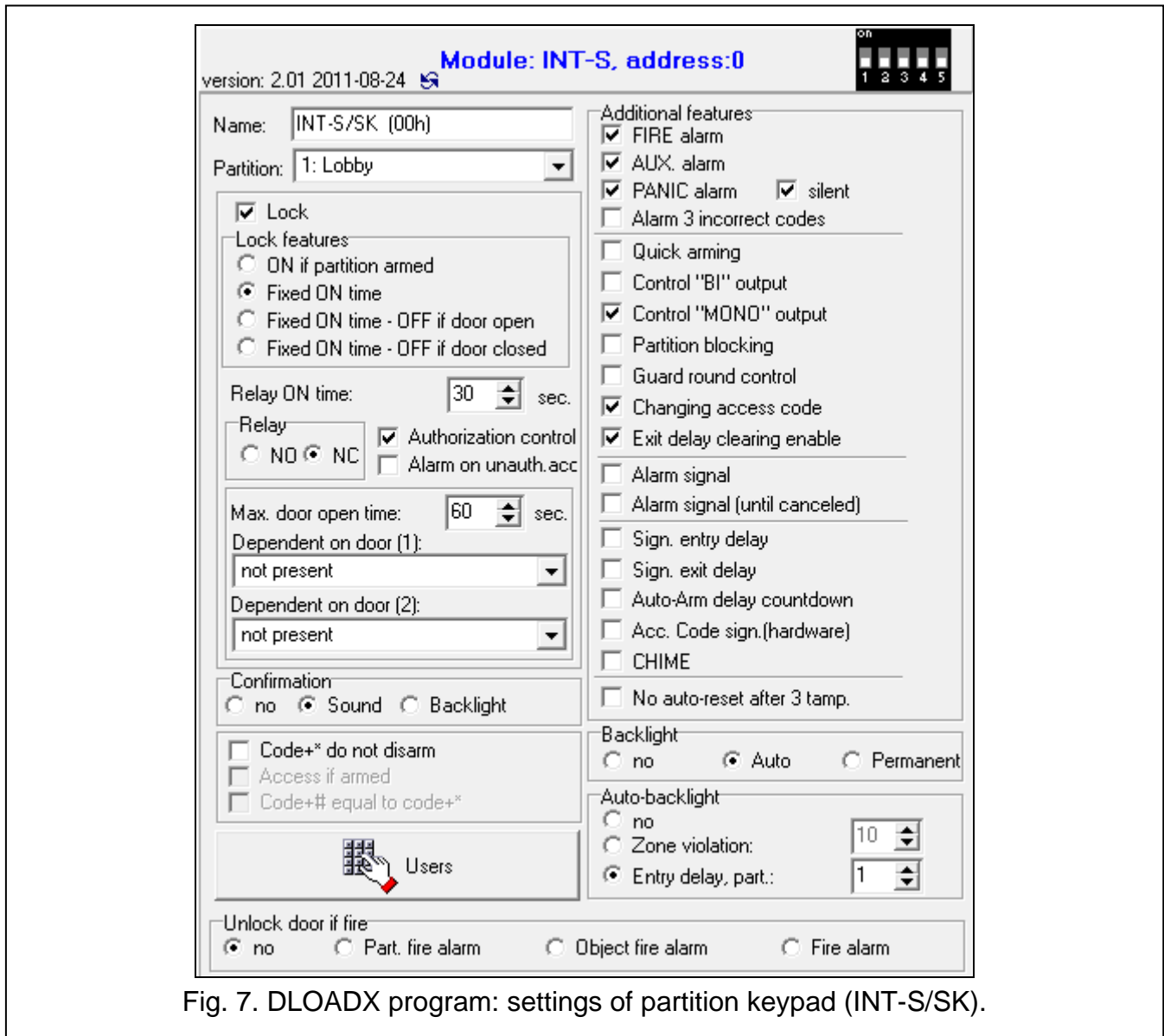

Fig. 7. DLOADX program: settings of partition keypad (INT-S/SK).

**Name** – individual name of the device (up to 16 characters).

**Partition** – partition operated by the keypad.

**Lock** [Lock feature] – if the option is enabled, the keypad can control access to a single door (the following parameters are available: “Lock features”, “Relay ON time”, “Max. door open time” etc.).

**Lock features** [Lock function] – mode of operation of the relay output after the access is granted:

**ON if partition armed** [On if part.armed] – the relay output will be turned on until the partition is armed. When the partition is armed, users cannot get access (to get access, the user must disarm the partition).

**Fixed ON time** [ON time] – the relay output will be turned on for the “Relay ON time”.

**Fixed ON time – OFF if door open** [ON, open→off] – the relay output will be turned on until the door is opened (door status input is disconnected from common ground), however not longer than for the “Relay ON time”.

**Fixed ON time – OFF if door closed** [ON, close→off] – the relay output will be turned on until the door is closed (door status input is reconnected to common ground), however not longer than for the “Relay ON time”.

**Relay ON time** – the time during which the relay output can be turned on after the access is granted. You can program from 1 to 255 seconds. The parameter does not apply to the “ON if partition armed” mode.

**Relay ON time** – the time period during which the relay can be ON after the access is granted. You can enter from 1 to 255 seconds.

**Relay** [Relay type] – do not configure (the parameter is irrelevant to the behavior of the multifunctional keypad relay).

**Authorization control** [Unauth. event] – if this option is enabled, unauthorized opening of the door will save the event to the control panel memory.

**Alarm on unauth. access** [Unauth. alarm] – if this option is enabled, unauthorized opening of the door when the partition is armed will trigger an alarm. The option is available if the “Authorization control” option is enabled.

**Max. door open time** [Max. door open] – the maximum period of time during which the door can be open (the door status input can be disconnected from common ground). If the door is open longer, audible alarm will be triggered in the keypad, and the event will be saved to the control panel memory. You can enter from the 0 to 255 seconds. If you enter 0, the door can be open for any long period of time.

**Dependent on door (1) / Dependent on door (2)** – you can select the door that must be closed so that the user can get access (turn the relay output on). It allows you to create an airlock. You may select a door supervised by another expander or alarm system zone programmed as type “57 Technical – door open”.

**Confirmation** – method of providing feedback to the user after using the keypad:

**No** – no feedback.

**Sound** – the keypad will use sounds to give feedback to the user.

**Backlight** – the keypad will use key backlight to give feedback to the user.

**Code+\* do not disarm** [Code\* not dis.] – if this option is enabled, entering the code and pressing **\*** will not disarm the partition (to disarm the partition, the user must enter the code and press **#**).

**Access if armed** [Code\* in arm] – if the option is enabled, the users can gain access (turn the relay output on) when the partition is armed. If the option is disabled, the users cannot gain access when the partition is armed. The option is available, if the “Code+\* do not disarm” option is enabled. The option does not apply to the “ON if partition armed” mode.

**Users** [Master users / Users] – the administrators and users which are permitted to use the keypad.

**FIRE alarm** – if this option is enabled, pressing and holding **#** for 3 seconds will trigger the fire alarm.

**AUX. alarm** [Medical alarm] – if this option is enabled, pressing and holding **□** for 3 seconds will trigger the medical alarm.

**PANIC alarm** – if this option is enabled, pressing and holding **\*** for 3 seconds will trigger the panic alarm.

**silent** [Silent panic] – if this option is enabled, the panic alarm triggered from the keypad will be a silent one, i.e. the keypad will not indicate it, there will be no audible signal, but the alarm will be reported to the monitoring station. The silent panic alarm is useful when the control panel is sending events to the monitoring station, but unauthorized persons should not be aware of the alarm being triggered. This option is available, if the “PANIC alarm” option is enabled.

**Alarm 3 incorrect codes** [3 wrong codes] – if this option is enabled, using an incorrect code three times will trigger an alarm.

- Quick arming** [Quick arm] – if the option is enabled, the user needs no code to arm the partition using the keypad.
- Control “BI” output** [BI outs ctrl.] – if this option is enabled, the ““BI” output operating” type of users can use the keypad to control outputs.
- Control “MONO” output** [MONO outs ctr.] – if this option is enabled, the ““Mono” output operating” type of users can use the keypad to control outputs.
- Partition blocking** [Part.blocking] – if the option is enabled, using the code by a user of the “Blocking partition” or “Guard” type will block the partition (violating a zone belonging to the partition will trigger no alarm). The duration of blocking is to be defined for the partition or the user (the user of “Blocking partition” type).
- Guard round control** [Guard control] – if this option is enabled, using the code by a user of the “Guard” type will be registered as the guard round.
- Changing access code** [Changing code] – if this option is enabled, the user can change own code from the keypad.
- Exit delay clearing enable** [Fin.exit time] – if the option is enabled, the user can terminate the partition exit delay countdown by pressing successively **9** and **#** (if the “Exit delay clearing” option is enabled for the partition).
- Alarm signal** [Alarm (time)] – if this option is enabled, the keypad will audibly signal alarms throughout the “Global alarm time” (parameter programmed in the control panel).
- Alarm signal (until canceled)** [Alarm (latch)] – if this option is enabled, the keypad will audibly signal alarms until they are cleared.
- Sign. entry delay** [Entry time] – if this option is enabled, the keypad will audibly signal the entry delay countdown.
- Sign. exit delay** [Exit time] – if this option is enabled, the keypad will audibly signal the exit delay countdown.
- Auto-Arm delay countdown** [Auto-arm delay] – if this option is enabled, the keypad will audibly signal the auto-arm delay countdown.
- Acc. code sign. (hardware)** [Code entered] – if this option is enabled, the keypad will confirm with a single beep that the code is entered (signaling independent of the control panel). The signaling is useful when there is a delay between entering the code / presenting the card and the sounds emitted after verification of the code / card by the control panel.
- CHIME** [Chime zones] – if this option is enabled, the keypad will audibly signal violation of zones with “Chime in module” option enabled, belonging to the partition operated by means of the keypad.
- No auto-reset after 3 tamp.** [No autorst.3t.] – if this option is enabled, the feature reducing the number of tamper alarms from the module to three is disabled (the feature prevents multiple logging of the same events and applies to successive uncleared alarms).
- Backlight** – the way how the keys backlight works:
- No** – always off.
  - Auto** – on for about 40 seconds after pressing any key. Additionally, it can be turned on if a specific event occurs (see the “Auto-backlight” parameter).
  - Permanent** – always on.
- Auto-backlight** – if the keys backlight goes on automatically, you can define whether and what event will additionally turn on the backlight:
- No** – the keys backlight will not be additionally turned on.
  - Zone violation** – the keys backlight will additionally go on if a selected zone is violated.



**Entry delay, part.** – the keys backlight will additionally go on if entry delay countdown starts in the selected partition.

**Unlock door if fire** [Doors on fire] – you can define whether and when the fire alarm will unlock the door controlled by the keypad (i.e. will activate the relay output):

**No** [no open] – the door will not be unlocked in the event of fire alarm.

**Part. fire alarm** [on partit. fire] – the door will be unlocked in the event of fire alarm in the partition to which the keypad is assigned.

**Object fire alarm** [on object fire] – the door will be unlocked in the event of fire alarm in the object to which the keypad is assigned.

**Fire alarm** [on any fire] – the door will be unlocked in the event of fire alarm in the alarm system.

## 5. Using the keypad

Most features are available on using the code or proximity card by the user.

By default, the following codes are preprogrammed in the control panel:

**service code: 12345**

**object 1 master user (administrator) code: 1111**



The factory default codes should be changed before you start using the alarm system.



**Do not make your code available to other people.**

The keypad distinguishes between presenting and holding the card (in the latter case the card must be held in front of the reader for about 3 seconds).

How the keypad behaves depends on the selected operating mode.

### 5.1 Partition keypad with proximity card reader (INT-SCR)

#### LED indicators

LED	Color	Description
	red	<b>ON</b> or <b>flashing</b> – alarm or alarm memory
	green	<b>ON</b> – partition is armed <b>flashing</b> – exit delay countdown is running in the partition
	yellow	<b>flashing</b> – trouble or trouble memory (the LED goes out when the partition is armed)



Information about the armed state can be extinguished after a preset time.

Flashing of the LEDs successively from left to right indicates no communication with the control panel.

## Sound signaling

### **Beeps generated when operating**

**i** | *The installer can disable the sound signaling or replace it with flashing of the keypad backlight (see “Configuring the keypad”).*

**1 short beep** – any number key is pressed or the code / card is used.

**2 short beeps** – the first code / card is accepted during two code arming / disarming.

**3 short beeps** – confirmation of:

- starting the arming procedure (there is exit delay in the partition) or arming (there is no exit delay in the partition),
- disarming and/or alarm clearing.

**4 short and 1 long beeps** – function is executed.

**3 pairs of short beeps** – code change is required.

**1 long beep** – refusal to arm (there are violated zones in the partition or there is a trouble).

**2 long beeps** – incorrect code / card.

**3 long beeps** – unavailable function.

### **Event signaling**

**i** | *The installer defines whether events are to be signaled audibly (see “Configuring the keypad”).*

**5 short beeps** – zone violation (CHIME).

**Long beep every 3 seconds, followed by a series of short beeps for 10 seconds and 1 long beep** – countdown of exit delay (if the time is shorter than 10 seconds, only the final sequence of short beeps will be generated).

**A sequence of 7 beeps of diminishing duration, repeated every few seconds** – countdown of auto-arming delay.

**2 short beeps every seconds** – countdown of entry delay.

**Continuous beep** – alarm.

**Long beep every 2 seconds** – alarm memory.

**Long beep every second** – fire alarm.

**Short beep every 2 seconds** – fire alarm memory.

**Very short beeps** – door open too long.

### **Available functions**

Availability of the functions depends on:

- type and rights of the user,
- keypad settings,
- partition state.

### **[Code] \* / presenting the card**



Enter the code and press \* / present the card to:



- disarm the partition,
- clear alarm,
- gain access (turn on the keypad relay),
- toggle the state of “25. BI switch” type outputs,
- turn on the “24. MONO switch” type outputs,

- confirm the guard round,
- temporary block the partition.

You can start two or more functions at the same time (e.g. disarming, alarm clearing and getting access).



*If you use the code or card and the  and  LEDs start flashing alternately, this will mean that the code and the card must be used to run the functions.*

*If you use the code/card to disarm the partition and the  and  LEDs start flashing alternately, this will mean that the keypad is waiting for the code/card of the other user (disarming using 2 codes).*



### **[Code] / holding the card**



Enter the code and press  / hold the card to:

- start the procedure of partition arming / arm the partition,
- disarm the partition,
- clear alarm,
- gain access (turn on the keypad relay),
- toggle the state of “25. BI switch” type outputs,
- turn on the “24. MONO switch” type outputs,
- confirm the guard round,
- temporary block the partition.
- unblock access to cash machine.

You can start two or more functions at the same time (e.g. disarming, alarm clearing and getting access).







*If you use the code or card and the  and  LEDs start flashing alternately, this will mean that the code and the card must be used to run the functions.*

*If you use the code/card to arm / disarm the partition and the  and  LEDs start flashing alternately, this will mean that the keypad is waiting for the code/card of the other user (arming / disarming using 2 codes).*

### **Quick arming**

The installer may permit arming without using the code / card.

1. To select the arming mode, press one of the keys:

-  - full arming,
-  - full arming + bypasses,
-  - arming without interior,
-  - arming without interior and without entry delay.

2. Press . This will start the partition arming procedure (if the exit delay is 0, the partition will be armed instantly).

### **Triggering the alarm from keypad**

The installer can permit triggering alarms from the keypad. To trigger an alarm, do the following:

**fire alarm** – press and hold down  for about 3 seconds,

**medical (auxiliary) alarm** – press and hold down  for about 3 seconds,







**panic alarm** – press and hold down  for about 3 seconds. The installer defines whether the audible or silent panic alarm will be triggered.

### ***Silencing the alarm sound at the keypad***

Press any number key to silence the keypad sounder during an alarm condition for about 40 seconds.



### ***Code changing***

You can change your code if the “Changing access code” option is enabled.

1. Press and hold the  key for about 3 seconds.
2. When the  and  LEDs start flashing alternately, enter the old code and press .
3. When the  and  LEDs start flashing alternately, enter the new code and press .

### **Impact of the EN 50131 standard on keypad use**

If the control panel is configured in accordance with the requirements of Standard EN 50131 for Grade 2 (INTEGRA) or Grade 3 (INTEGRA Plus):

- the keypad does not signal alarms,
- the  LED indicates alarms only after entering the code / reading the card,
- flashing of the  LED indicates a trouble, bypassed zones or an alarm,
- the  LED goes out after 60 seconds (Grade 3),
- quick arming features are not available,
- arming procedure cannot be initiated, if there are violated zones in the partition or there is a trouble in the system,
- the partition will not be armed if, at the moment of completion of exit delay countdown:
  - there is a violated zone in partition which was not violated when the arming procedure was started,
  - there is a trouble which did not exist when the arming procedure was started.

## **5.2 Entry keypad (INT-ENT)**

---

### **LED indicators**

LED	Color	Description
	green	<b>flashing</b> – delay activation time countdown is running



*Flashing of the LEDs successively from left to right indicates no communication with the control panel.*

### **Sound signaling**

#### ***Beeps generated when operating***



*The installer can disable the sound signaling or replace it with flashing of the keypad backlight (see “Configuring the keypad”).*

**1 short beep** – any number key is pressed or the code / card is used.

**3 short beeps** – delay is activated.

**4 short and 1 long beeps** – function is executed.

**3 pairs of short beeps** – code change is required.

**2 long beeps** – incorrect code / card.

**3 long beeps** – unavailable function.

### **Event signaling**



*The installer defines whether events are to be signaled audibly (see “Configuring the keypad”).*

**Short beep every 3 seconds** – countdown of delay activation time.

### **Available functions**

Availability of the functions depends on:

- type and rights of the user,
- keypad settings,
- partition state.

Use the code (whether you press **\*** or **#** after entering the code is irrelevant) / card (whether you present or hold the card is irrelevant) to:

- activate delay for the “3. Interior delayed” type zones,
- toggle the state of “25. BI switch” type outputs,
- turn on the “24. MONO switch” type outputs,
- confirm the guard round.

## **5.3 Partition keypad (INT-S/SK)**

In this mode, the keypad behaves in much the same way as in the partition keypad with proximity card reader mode, but the proximity cards are not supported. For information on how to use the keypad, refer to section “Partition keypad with proximity card reader (INT-SCR)”. Just skip the fragments relating to the use of proximity cards.

## **6. Specifications**

Supply voltage .....	12 VDC ±15%
Standby current consumption .....	105 mA
Maximum current consumption .....	125 mA
Reader transmit frequency .....	125 kHz
Relay output (resistive load) .....	1 A / 30 VDC
BELL output, OC type .....	30 mA / 12 VDC
Operating temperature range .....	-25°C...+55°C
Maximum humidity .....	93±3%
Dimensions .....	47 x 158 x 24 mm
Cable length .....	4 m
Weight .....	297 g