



Video Access Control Terminal

User Manual

User Manual

©2019 Hangzhou Hikvision Digital Technology Co., Ltd.

It includes instructions on how to use the Product. The software embodied in the Product is governed by the user license agreement covering that Product.

About this Manual

This Manual is subject to domestic and international copyright protection. Hangzhou Hikvision Digital Technology Co., Ltd. (“Hikvision”) reserves all rights to this manual. This manual cannot be reproduced, changed, translated, or distributed, partially or wholly, by any means, without the prior written permission of Hikvision.

Trademarks

HIKVISION and other Hikvision marks are the property of Hikvision and are registered trademarks or the subject of applications for the same by Hikvision and/or its affiliates. Other trademarks mentioned in this manual are the properties of their respective owners. No right of license is given to use such trademarks without express permission.

Disclaimer

TO THE MAXIMUM EXTENT PERMITTED BY APPLICABLE LAW, HIKVISION MAKES NO WARRANTIES, EXPRESS OR IMPLIED, INCLUDING WITHOUT LIMITATION THE IMPLIED WARRANTIES OF MERCHANTABILITY AND FITNESS FOR A PARTICULAR PURPOSE, REGARDING THIS MANUAL. HIKVISION DOES NOT WARRANT, GUARANTEE, OR MAKE ANY REPRESENTATIONS REGARDING THE USE OF THE MANUAL, OR THE CORRECTNESS, ACCURACY, OR RELIABILITY OF INFORMATION CONTAINED HEREIN. YOUR USE OF THIS MANUAL AND ANY RELIANCE ON THIS MANUAL SHALL BE WHOLLY AT YOUR OWN RISK AND RESPONSIBILITY.

REGARDING TO THE PRODUCT WITH INTERNET ACCESS, THE USE OF PRODUCT SHALL BE WHOLLY AT YOUR OWN RISKS. OUR COMPANY SHALL NOT TAKE ANY RESPONSIBILITIES FOR ABNORMAL OPERATION, PRIVACY LEAKAGE OR OTHER DAMAGES RESULTING FROM CYBER ATTACK, HACKER ATTACK, VIRUS INSPECTION, OR OTHER INTERNET SECURITY RISKS; HOWEVER, OUR COMPANY WILL PROVIDE TIMELY TECHNICAL SUPPORT IF REQUIRED.

SURVEILLANCE LAWS VARY BY JURISDICTION. PLEASE CHECK ALL RELEVANT LAWS IN YOUR JURISDICTION BEFORE USING THIS PRODUCT IN ORDER TO ENSURE THAT YOUR USE CONFORMS THE APPLICABLE LAW. OUR COMPANY SHALL NOT BE LIABLE IN THE EVENT THAT THIS PRODUCT IS USED WITH ILLEGITIMATE PURPOSES.

IN THE EVENT OF ANY CONFLICTS BETWEEN THIS MANUAL AND THE APPLICABLE LAW, THE LATER PREVAILS.

Support

Should you have any questions, please do not hesitate to contact your local dealer.

Data Protection

During the use of device, personal data will be collected, stored and processed. To protect data, the development of Hikvision devices incorporates privacy by design principles. For example, for device with facial recognition features, biometrics data is stored in your device with encryption method; for fingerprint device, only fingerprint template will be saved, which is impossible to reconstruct a fingerprint image.

As data controller, you are advised to collect, store, process and transfer data in accordance with the applicable data protection laws and regulations, including without limitation, conducting security controls to safeguard personal data, such as, implementing reasonable administrative and physical security controls, conduct periodic reviews and assessments of the effectiveness of your security controls.

Regulatory Information

FCC Information

Please take attention that changes or modification not expressly approved by the party responsible for compliance could void the user's authority to operate the equipment.

FCC compliance: This equipment has been tested and found to comply with the limits for a Class B digital device, pursuant to part 15 of the FCC Rules. These limits are designed to provide reasonable protection against harmful interference in a residential installation. This equipment generates, uses and can radiate radio frequency energy and, if not installed and used in accordance with the instructions, may cause harmful interference to radio communications. However, there is no guarantee that interference will not occur in a particular installation. If this equipment does cause harmful interference to radio or television reception, which can be determined by turning the equipment off and on, the user is encouraged to try to correct the interference by one or more of the following measures:

- Reorient or relocate the receiving antenna.
- Increase the separation between the equipment and receiver.
- Connect the equipment into an outlet on a circuit different from that to which the receiver is connected.
- Consult the dealer or an experienced radio/TV technician for help.

This equipment should be installed and operated with a minimum distance 20cm between the radiator and your body.

FCC Conditions

This device complies with part 15 of the FCC Rules. Operation is subject to the following two conditions:

1. This device may not cause harmful interference.
2. This device must accept any interference received, including interference that may cause undesired operation.

EU Conformity Statement



This product and - if applicable - the supplied accessories too are marked with "CE" and comply therefore with the applicable harmonized European standards listed under the RE Directive 2014/53/EU, the EMC Directive 2014/30/EU, the RoHS Directive 2011/65/EU.



2012/19/EU (WEEE directive): Products marked with this symbol cannot be disposed of as unsorted municipal waste in the European Union. For proper recycling, return this product to your local supplier upon the purchase of equivalent new equipment, or dispose of it at designated collection points. For more information see: www.recyclethis.info



2006/66/EC (battery directive): This product contains a battery that cannot be disposed of as unsorted municipal waste in the European Union. See the product documentation for specific battery information. The battery is marked with this symbol, which may include lettering to indicate cadmium (Cd), lead (Pb), or mercury (Hg). For proper recycling, return the battery to your supplier or to a designated collection point.

For more information see: www.recyclethis.info

Industry Canada ICES-003 Compliance

This device meets the CAN ICES-3 (B)/NMB-3(B) standards requirements.

This device complies with Industry Canada licence-exempt RSS standard(s). Operation is subject to the following two conditions:

- (1) this device may not cause interference, and
 - (2) this device must accept any interference, including interference that may cause undesired operation of the device.
- Le présent appareil est conforme aux CNR d'Industrie Canada applicables aux appareils radioexempts de licence. L'exploitation est autorisée aux deux conditions suivantes :
- (1) l'appareil ne doit pas produire de brouillage, et
 - (2) l'utilisateur de l'appareil doit accepter tout brouillage radioélectrique subi, même si le brouillage est susceptible d'en compromettre le fonctionnement.

Under Industry Canada regulations, this radio transmitter may only operate using an antenna of a type and maximum (or lesser) gain approved for the transmitter by Industry Canada. To reduce potential radio interference to other users, the antenna type and its gain should be so chosen that the equivalent isotropically radiated power (e.i.r.p.) is not more than that necessary for successful communication.

Conformément à la réglementation d'Industrie Canada, le présent émetteur radio peut fonctionner avec une antenne d'un type et d'un gain maximal (ou inférieur) approuvé pour l'émetteur par Industrie Canada. Dans le but de réduire les risques de brouillage radioélectrique à l'intention des autres utilisateurs, il faut choisir le type d'antenne et son gain de sorte que la puissance isotrope rayonnée équivalente (p.i.r.e.) ne dépasse pas l'intensité nécessaire à l'établissement d'une communication satisfaisante.

This equipment should be installed and operated with a minimum distance 20cm between the radiator and your body. Cet équipement doit être installé et utilisé à une distance minimale de 20 cm entre le radiateur et votre corps.



Safety Instruction

These instructions are intended to ensure that user can use the product correctly to avoid danger or property loss.

The precaution measure is divided into **Warnings** and **Cautions**:

Warnings: Neglecting any of the warnings may cause serious injury or death.

Cautions: Neglecting any of the cautions may cause injury or equipment damage.

	
Warnings Follow these safeguards to prevent serious injury or death.	Cautions Follow these precautions to prevent potential injury or material damage.



Warnings

- All the electronic operation should be strictly compliance with the electrical safety regulations, fire prevention regulations and other related regulations in your local region.
- Please use the power adapter, which is provided by normal company. The power consumption cannot be less than the required value.
- Do not connect several devices to one power adapter as adapter overload may cause over-heat or fire hazard.
- Please make sure that the power has been disconnected before you wire, install or dismantle the device.
- When the product is installed on wall or ceiling, the device shall be firmly fixed.
- If smoke, odors or noise rise from the device, turn off the power at once and unplug the power cable, and then please contact the service center.
- If the product does not work properly, please contact your dealer or the nearest service center. Never attempt to disassemble the device yourself. (We shall not assume any responsibility for problems caused by unauthorized repair or maintenance.)



Cautions

- Do not drop the device or subject it to physical shock, and do not expose it to high electromagnetism radiation. Avoid the equipment installation on vibrations surface or places subject to shock (ignorance can cause equipment damage).
- Do not place the device in extremely hot (refer to the specification of the device for the detailed operating temperature), cold, dusty or damp locations, and do not expose it to high electromagnetic radiation. The appropriate operation temperature is 0°C to +45°C, and the storage temperature should be -10°C to +55°C.
- The device cover for indoor use shall be kept from rain and moisture.

- Exposing the equipment to direct sun light, low ventilation or heat source such as heater or radiator is forbidden (ignorance can cause fire danger).
- Do not aim the device at the sun or extra bright places. A blooming or smear may occur otherwise (which is not a malfunction however), and affecting the endurance of sensor at the same time.
- Please use the provided glove when open up the device cover, avoid direct contact with the device cover, because the acidic sweat of the fingers may erode the surface coating of the device cover.
- Please use a soft and dry cloth when clean inside and outside surfaces of the device cover, do not use alkaline detergents.
- Please keep all wrappers after unpack them for future use. In case of any failure occurred, you need to return the device to the factory with the original wrapper. Transportation without the original wrapper may result in damage on the device and lead to additional costs.
- Improper use or replacement of the battery may result in hazard of explosion. Replace with the same or equivalent type only. Dispose of used batteries according to the instructions provided by the battery manufacturer.
- Please take care of your card and report card loss in time when card is lost.
- If you require a higher security level, use multiple authentication modes.
- Multiple card types are supported. Please select an appropriate card type according to the card performance and the usage scenarios.

Table of Contents

1 Overview	3
1.1 Introduction	3
1.2 Main Features	3
2 Appearance	4
2.1 Appearance of DS-K1T500S Model	4
2.2 Video Access Control Terminal Connector	5
3 Installation	6
4 Terminal Connection	7
5 Wiring Description	9
5.1 External Device Wiring Overview	9
5.2 The Wiring of External Card Reader	10
5.2.1 The Wiring of External RS-485 Card Reader	10
5.3 Card Reader Connection	10
5.3.1 The Wiring of Wiegand	11
5.3.2 The Wiring of RS-485 Output	11
6 Activating the Access Control Terminal	12
6.1 Activating via SADP Software	12
6.2 Activating via Client Software	13
7 iVMS-4200 Access Control Client Operation	16
7.1 Overview of iVMS-4200 Client Software	16
7.1.1 Description	16
7.1.2 Running Environment	16
7.1.3 Client Performance	16
7.2 Resource Management	17
7.2.1 Access Control Device Management	17
7.2.2 Network Settings	38
7.2.3 Capture Settings	40
7.2.4 RS-485 Settings	41
7.2.5 Door Group Management	42
7.3 Permission Configuration	45
7.3.1 Person Management	45
7.3.2 Card Management	51
7.3.3 Schedule Template	57
7.3.4 Door Status Management	62
7.3.5 Linkage Configuration	66
7.3.6 Permission Configuration	70
7.3.7 Advanced Functions	74
7.4 Event and Alarm Management	87
7.4.1 Real-Time Access Control Event and Alarm	87
7.4.2 Event Management	88
7.5 System Maintenance	90
7.5.1 Log Management	90
7.5.2 Account Management	91
7.5.3 Auto Backup Settings	92
7.5.4 System Configuration	92
8 iVMS-4200 Control Client Operation	97
8.1 Importing Access Control Device	97
8.2 Live View and Playback Settings	97
8.3 Group Management	99
8.3.1 Adding the Group	99
8.3.2 Importing Encoding Device to Group	100
8.3.3 Editing the Group/Camera	101
8.3.4 Removing Cameras from the Group	101

8.3.5 Deleting the Group	102
8.4 Live View.....	102
8.4.1 Starting and Stopping the Live View	105
8.4.2 Manual Recording and Capture	107
8.4.3 Instant Playback.....	109
8.4.4 Custom Window Division	111
8.4.5 Other Functions in Live View	112
8.5 Playback.....	113
8.5.1 Storing on Storage Device	113
8.5.2 Normal Playback.....	115
8.5.3 Event Playback.....	122
9 Appendix	125
9.1 DIP Switch Introduction.....	125
9.2 Indicator and Buzzer Description	126
9.3 Access Controller Model List.....	127

1 Overview

1.1 Introduction

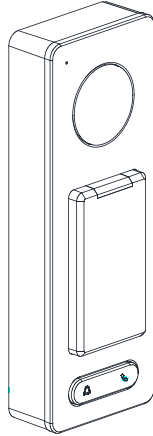

DS-K1T500S is a series video access control terminal with multiple advanced technologies including face detection, Wi-Fi, smart card recognition, and HD camera (2 MP optional). It supports offline operation.

1.2 Main Features

- Transmission modes of wired network (TCP/TP), Wi-Fi, RS-485, and Wiegand
- Face detection and picture capturing function implemented by built-in camera (2 MP optional)
- Supports RS-485 communication for connecting external card reader
- Supports working as a card reader, and supports Wiegand interface and RS-485 interface for accessing the controller
- Supports EHome
- Max. 50,000 cards Max. and 200,000 access control events records
- Supports multiple authentication modes including card, card + password, and so on.
- Supports Mifare card/ QR Code reading
- Tampering detection, unlocking overtime alarm, invalid card swiping over times alarm, duress card alarm, and so on
- Supports security door control unit connection
- Protection level: IP65
- Data can be permanently saved after power-off

2 Appearance

2.1 Appearance of DS-K1T500S Model

Please refer to the following content for detailed information of DS-K1T500S series model

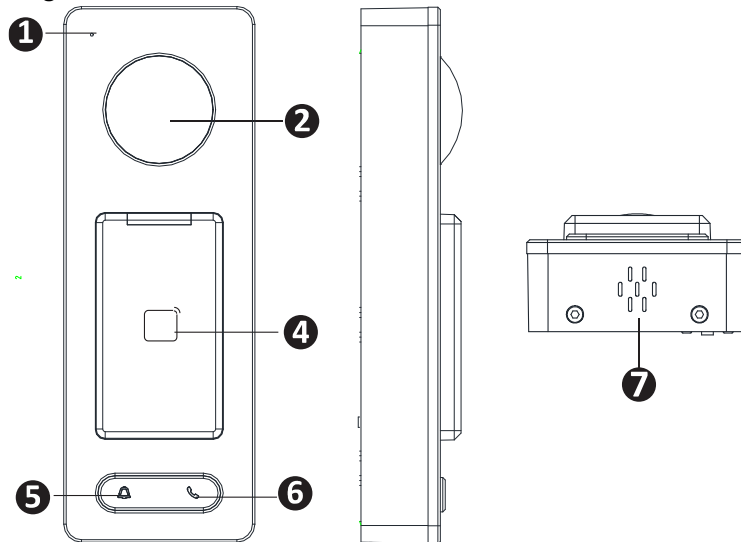

Table 2-1 Description of DS-K1T500S Series Model

No.	Description
1	Mic
2	Camera
3	LED Indicator
4	Card Swiping Area
5	Doorbell Button
6	Voice Talk Button
7	Loud Speaker

NOTE

In the Event Card Interact interface in the iVMS-4200 Client Software, choose the alarm output of Event Bell. You can connect a bell at the alarm output terminal. For details about configuring the Event Bell alarm output, see the *User Manual of iVMS- 4200 Client Software*.

2.2 Video Access Control Terminal Connector

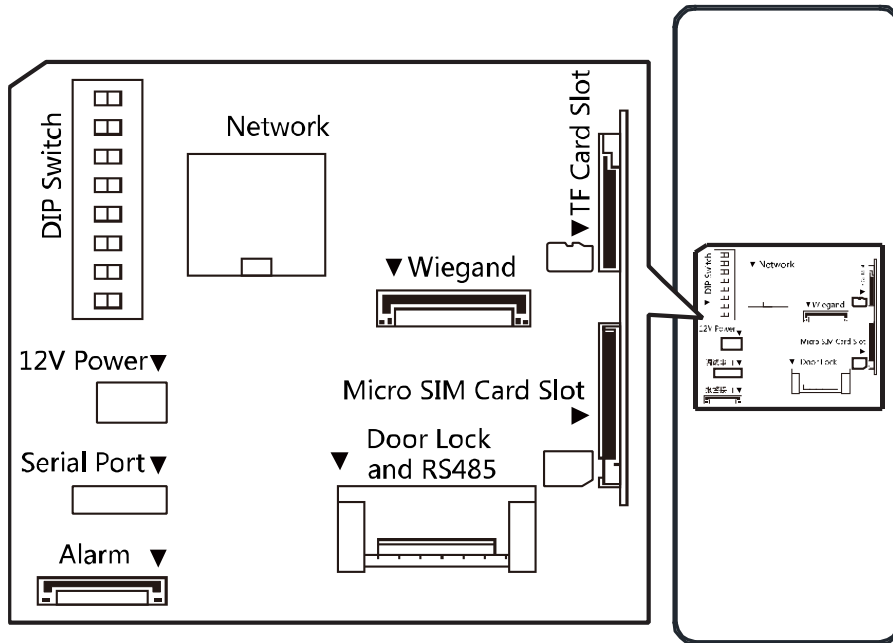

3 Installation

Before You Start:

- Make sure that the device in the package is in good condition and all the assembly parts are included.
- Make sure that the wall is strong enough to withstand three times the weight of the terminal.
- Set the DIP address before installation.

Steps:

1. Connect the cables with the connector on the rear panel of the device. Route the cables through the cable hole of the mounting plate. The cable holes are on the right side, left side and lower side of the rear cover. If the right/left side cable hole is selected, remove the plastic sheet of the cable hole.
2. Secure the mounting plate on the wall with 4 supplied screws.
3. Connect the corresponding cables.
4. Push the terminal in the mounting plate from bottom up.
5. Tighten the screws on the bottom of the terminal to fix the terminal on the mounting plate and complete the installation.

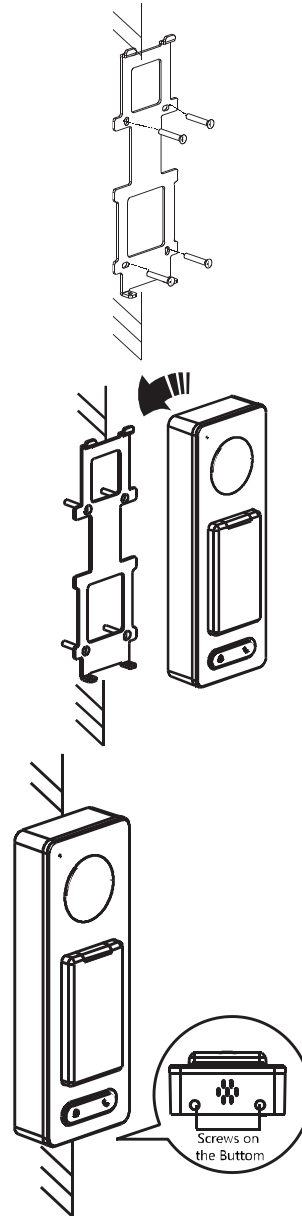

4 Terminal Connection

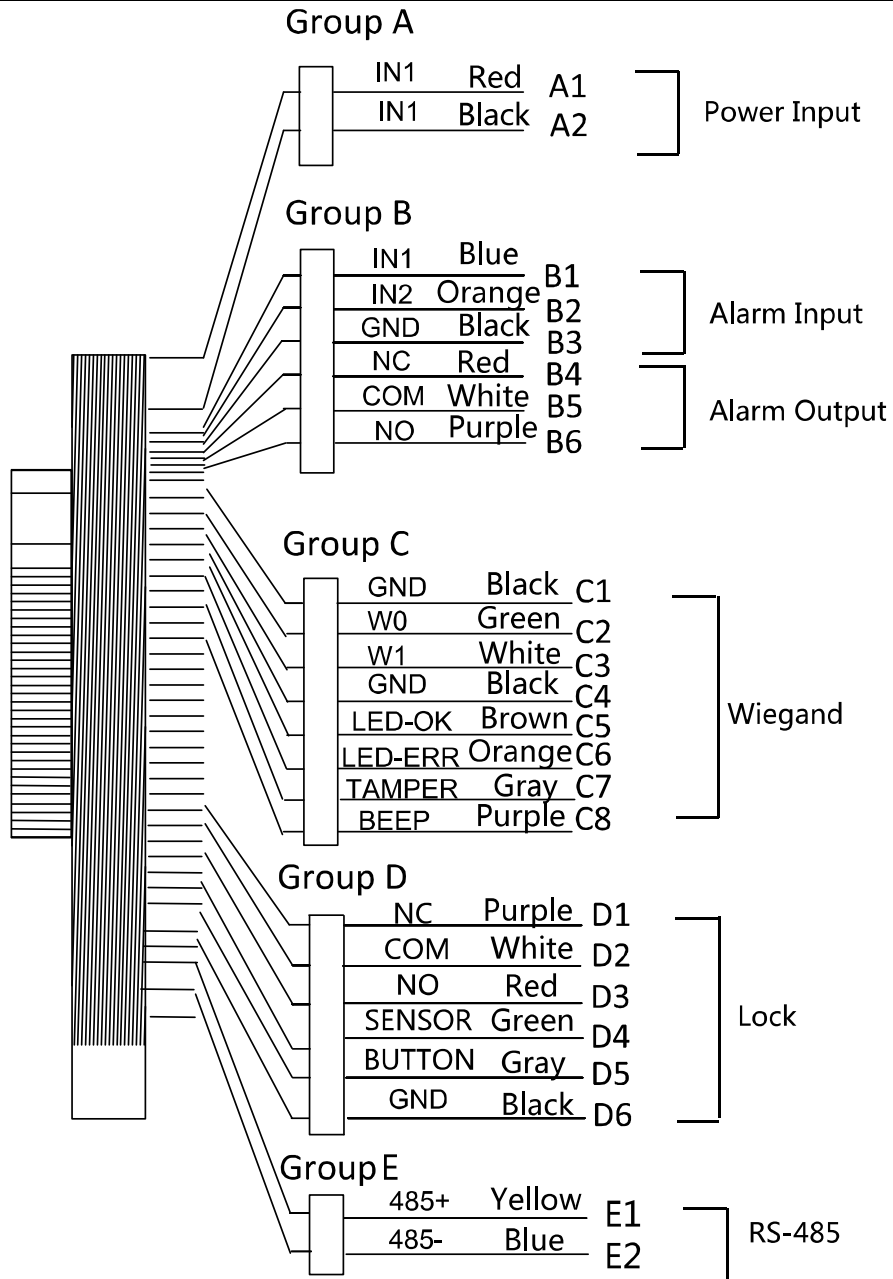
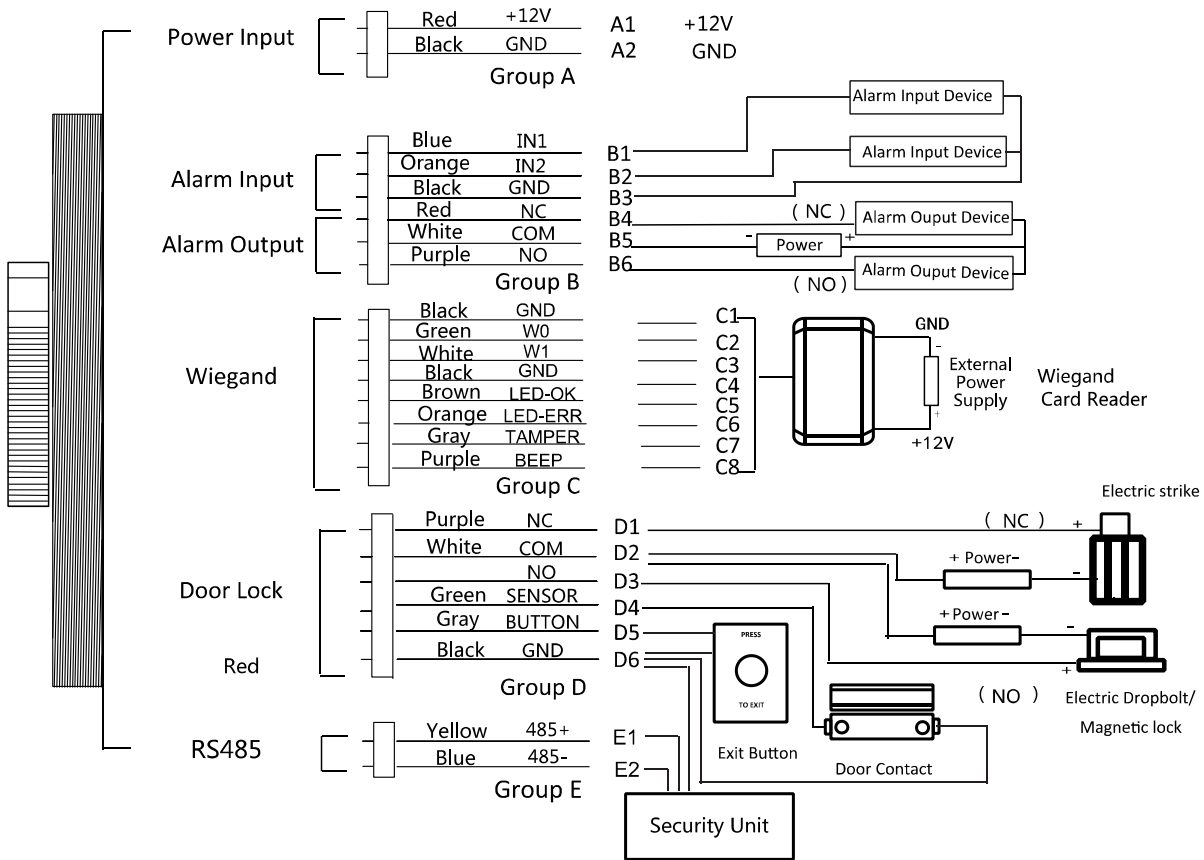

Table 4-1 Terminal Description

Group	No.	Function	Color	Terminal Name	Description
Group A	A1	Power Input	Red	+12V	12V DC Power Supply
	A2		Black	GND	GND
Group B	B1	Alarm Input	Yellow	IN1	Alarm Input 1
	B2		Orange	IN2	Alarm Input 2
	B3		Black	GND	GND
	B4	Alarm Output	Red	NC	Alarm Output Wiring
	B5		White	COM	
	B6		Purple	NO	
Group C	C1	Wiegand	Black	GND	GND
	C2		Green	W0	Wiegand Wiring 0
	C3		White	W1	Wiegand Wiring 1
	C4		Black	GND	GND
	C5		Brown	LED-OK	Wiegand Authenticated
	C6		Orange	LED-ERR	Wiegand Authentication Failed
	C7		Gray	TAMPER	Tampering Alarm Wiring
	C7		Purple	BEEP	Buzzer Wiring
Group D	D1	Lock	Purple	NC	Lock Wiring
	D2		White	COM	
	D3		Red	NO	
	D4		Green	SENSOR	Door Magnetic Signal Input
	D5		Gray	BUTTON	Exit Door Wiring
	D6		Black	GND	GND
Group E	E1	RS-485	Yellow	485 +	RS-485 Wiring
	E2		Blue	485 -	

5 Wiring Description

5.1 External Device Wiring Overview



Notes:

- If set the working mode as the controller mode, the terminal can connect the RS-485 card reader or security control unit via RS-485 protocol. For details about wiring of RS-485 card reader, see 5.2.1 The Wiring of External RS-485 Card Reader.
- If set the working mode as the controller mode, the terminal cannot connect the Wiegand card reader.
- The security control unit can also connect the external devices. For details, see the specified user manual of security control unit.

5.2 The Wiring of External Card Reader

5.2.1 The Wiring of External RS-485 Card Reader

If set the working mode as the controller mode, the DIP switch No.6 should be set as OFF.

If set the working mode as card reader mode, the DIP switch No. from 1 to 4 should be set as OFF.

Set the external card reader's RS-485 DIP switch to 2. For details about DIP switch configuration, see 9.1 DIP Switch Introduction.

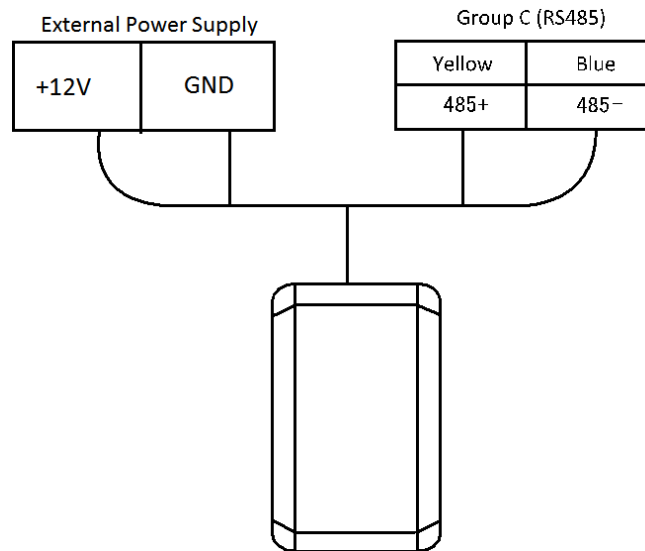

5.3 Card Reader Connection

The access control terminal can be switched into the card reader mode. It can access to the access control as a card reader, and supports Wiegand communication port and RS-485 communication port.

 **NOTE**

When the access control terminal works as a card reader, it only supports being connected to the controller, but does not support alarm input or output, or the connection of external devices.

5.3.1 The Wiring of Wiegand

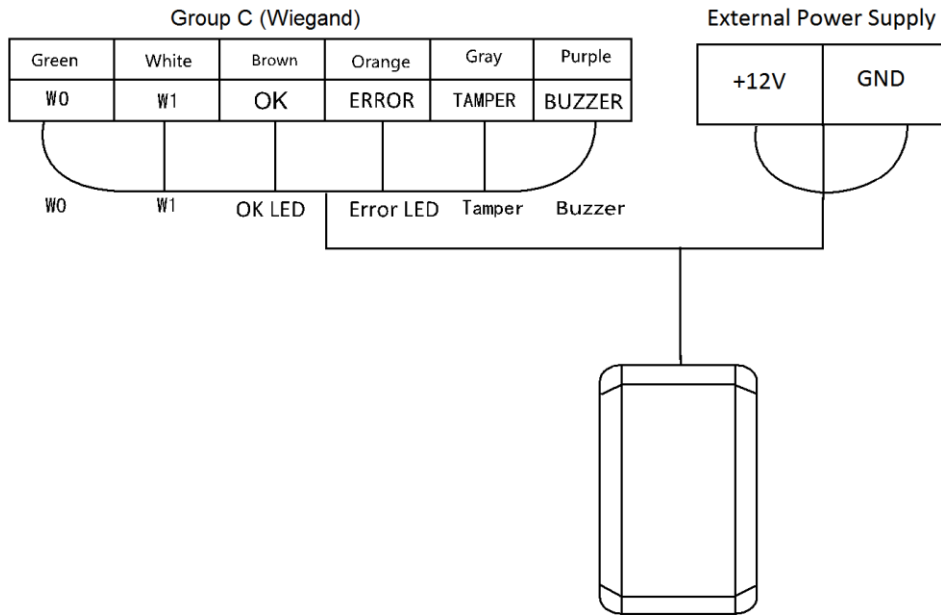

NOTE

- When the access control terminal works as a card reader, you must the **WG_ERR, BUZZER and WG_OK** interfaces if you want to control the LED and buzzer of the Wiegand card reader.
- Set the working mode of the terminal as card reader, if the terminal is required to work as a card reader. The card reader mode support to communicate by Wiegand or RS-485.
- The distance of Wiegand communication should be no longer than 80 m.
- The external power supply and the access control terminal should use the same GND cable.

5.3.2 The Wiring of RS-485 Output

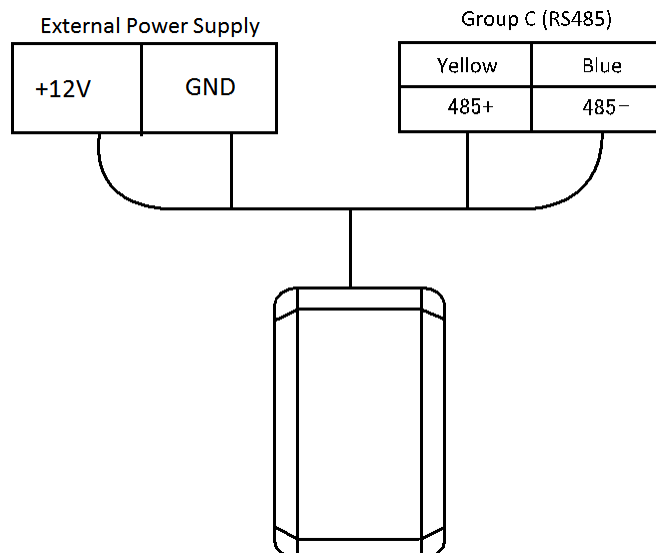

NOTE

- Set the working mode of the terminal as card reader, if the terminal requires working as a card reader.
- When the access control terminal works as a RS-485 card reader, you can set the RS-485 address via the DIP switch.
- The external power supply and the access control terminal should use the same GND cable.

6 Activating the Access Control Terminal

Purpose:

You are required to activate the terminal first before using it. Activation via SADP, and Activation via client software are supported. The default values of the control terminal are as follows.

- The default IP address: 192.0.0.64.
- The default port No.: 8000.
- The default user name: admin.

6.1 Activating via SADP Software

SADP software is used for detecting the online device, activating the device, and resetting the password. Get the SADP software from the supplied disk or the official website, and install the SADP according to the prompts. Follow the steps to activate the control panel.

Steps:

1. Run the SADP software to search the online devices.
2. Check the device status from the device list, and select an inactive device.

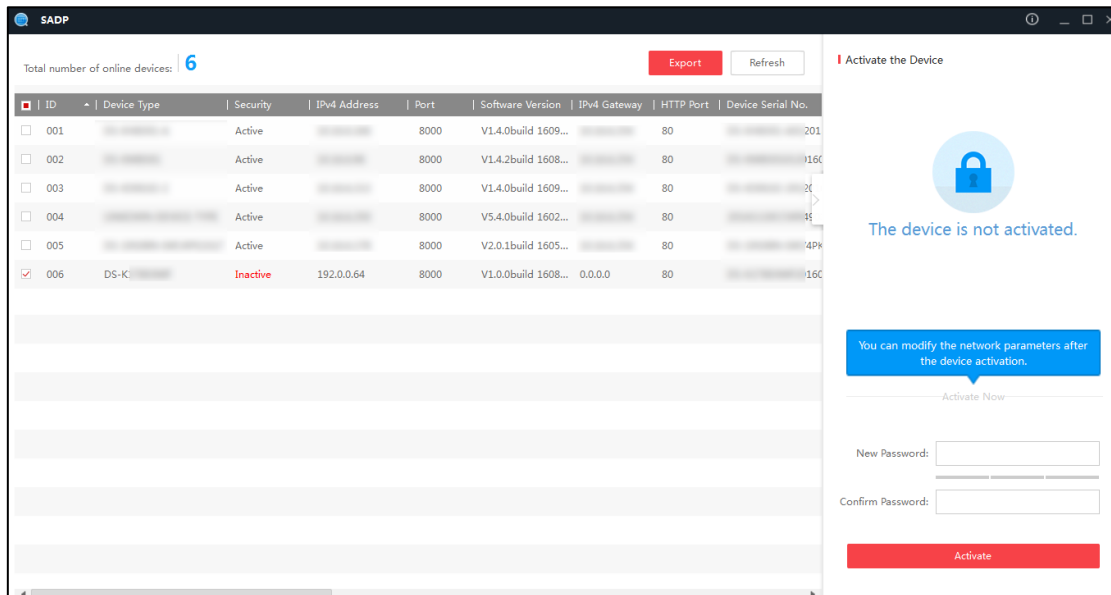

3. Create a password in the password field, and confirm the password.



STRONG PASSWORD RECOMMENDED— We highly recommend you create a strong password of your own choosing (using a minimum of 8 characters, including upper case letters, lower case letters, numbers, and special characters) in order to increase the security of your product. And we recommend you reset your password regularly, especially in the high security system, resetting the password monthly or weekly can better protect your product.

4. Click **Activate** to activate the device.
5. Check the activated device, you can change the device IP address to the same network segment with your computer by either modifying the IP address manually or checking the checkbox of Enable DHCP.

The screenshot shows a web form titled "Modify Network Parameters". At the top left, there is a red exclamation mark icon and the title. Below the title is a checkbox labeled "Enable DHCP". The form contains several input fields: "Device Serial No.", "IP Address", "Port" (with the value "8000" pre-filled), "Subnet Mask", "Gateway", "IPv6 Address" (with "::" pre-filled), "IPv6 Gateway" (with "::" pre-filled), "IPv6 Prefix Length" (with "0" pre-filled), and "HTTP Port" (with "80" pre-filled). Below these fields is a "Security Verification" section with an "Admin Password" input field. At the bottom, there is a prominent red "Modify" button and a blue "Forgot Password" link.

6. Input the password and click the **Modify** button to activate your IP address modification.

6.2 Activating via Client Software

The client software is versatile video management software for multiple kinds of devices.

Get the client software from the supplied disk or the official website, and install the software according to the prompts. Follow the steps to activate the control panel.

Steps:

1. Run the client software and the control panel of the software pops up, as shown in the figure below.

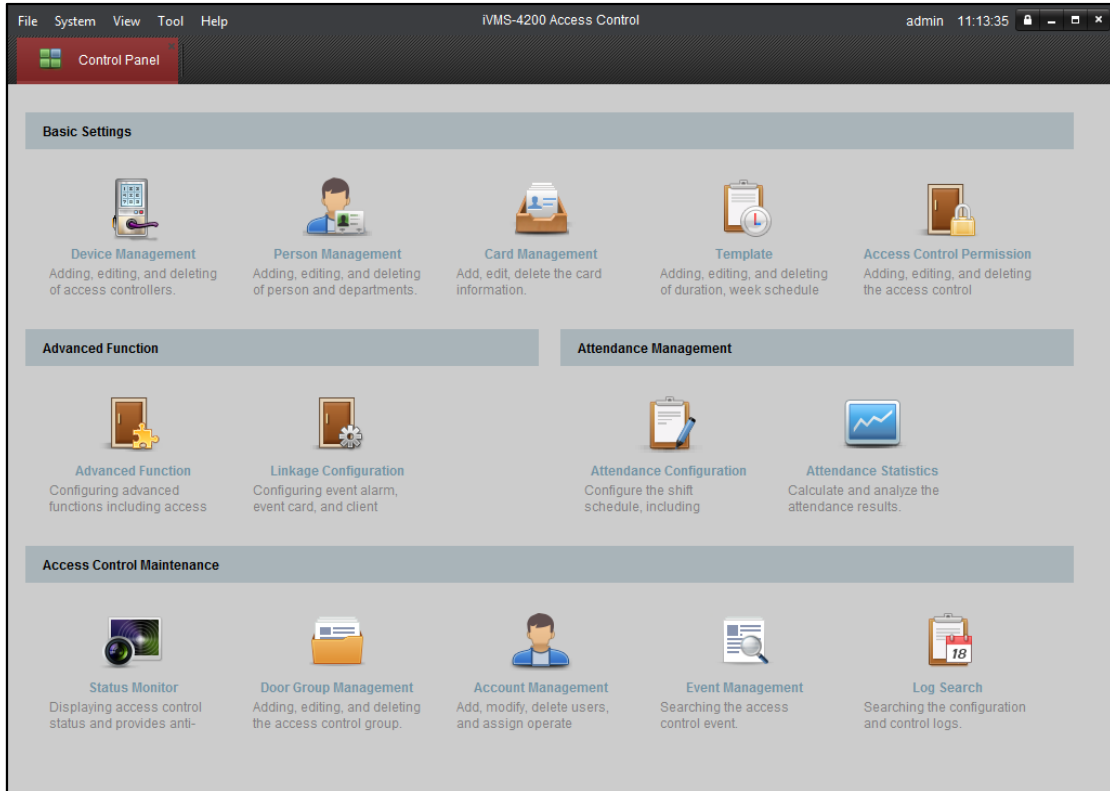

2. Click the **Device Management** to enter the Device Management interface.

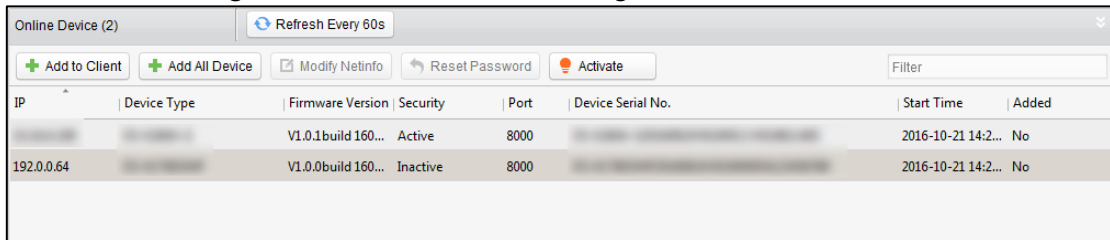

3. Check the device status from the online device list, and select an inactive device.

4. Click the **Activate** button to pop up the Activation interface.

5. In the pop-up window, create a password in the password field, and confirm the password.

 **STRONG PASSWORD RECOMMENDED**– We highly recommend you create a strong password of your own choosing (using a minimum of 8 characters, including upper case letters, lower case letters, numbers, and special characters) in order to increase the security of your product. And we recommend you reset your password regularly, especially in the high security system, resetting the password monthly or weekly can better protect your product.

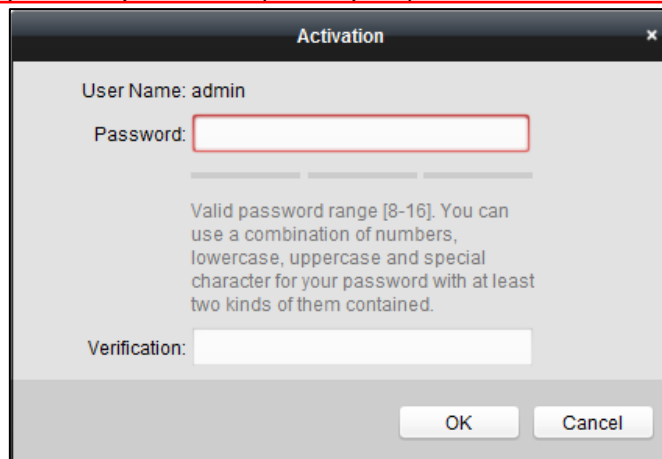

6. Click **OK** button to activate.
7. Click the **Modify Netinfor** button to pop up the Network Parameter Modification interface.

Modify Network Parameter

Device Information:

MAC Address: 44-19-b6-c7-62-f3

SoftVersion: V1.0.0build 161107

Serial No.: DS-K1T600SF20161107V010000CH6465039330

Network Information:

IP Address: 192.0.0.64

Port: 8000

Subnet Mask: 255.255.255.0

GateWay: 0.0.0.0

Password:

8. Change the device IP address to the same network segment with your computer by either modifying the IP address manually.
9. Input the password and click the **OK** button to save the settings.

7 iVMS-4200 Access Control Client Operation

7.1 Overview of iVMS-4200 Client Software

7.1.1 Description

The iVMS-4200 Access Control Client is a client-based access control system for management of access control devices. With intuitive and easy-to-use operations, it provides multiple functionalities, including access control device management, person/card management, permission configuration, door status management, attendance management, event search, etc.

This user manual describes the function, configuration and operation steps of iVMS-4200 Access Control Client. To ensure the properness of usage and stability of the client, please refer to the contents below and read the manual carefully before installation and operation.

7.1.2 Running Environment

Operating System: Microsoft Windows 7/Windows 2008 R2/Windows 8.1/Windows 10 (32-bit or 64-bit), Windows XP SP3 (32-bit)

CPU: Intel Pentium IV 3.0 GHz or above

Memory: 2G or above

Video Card: RADEON X700 Series or above

GPU: 256 MB or above



NOTE

- For high stability and good performance, these above system requirements must be met.
- The software does not support 64-bit operating system; the above mentioned 64-bit operating system refers to the system which supports 32-bit applications as well.

7.1.3 Client Performance

The client performance is shown as follows:

Client Performance	Quantity
User Account	Up to 16 user accounts (including super user) supported
Access Control Device	Up to 16 access control devices supported
Access Control Point	Up to 64 access control points (doors) supported
Person	Up to 2,000 persons supported
Card	Up to 2,000 cards supported
Department	Up to 10 levels of departments supported

7.2 Resource Management

After running the iVMS-4200 Access Control Client, the access control device should be added to the client for the remote configuration and management.

7.2.1 Access Control Device Management



Click **Device Management** icon on the control panel to enter the access control device management interface.

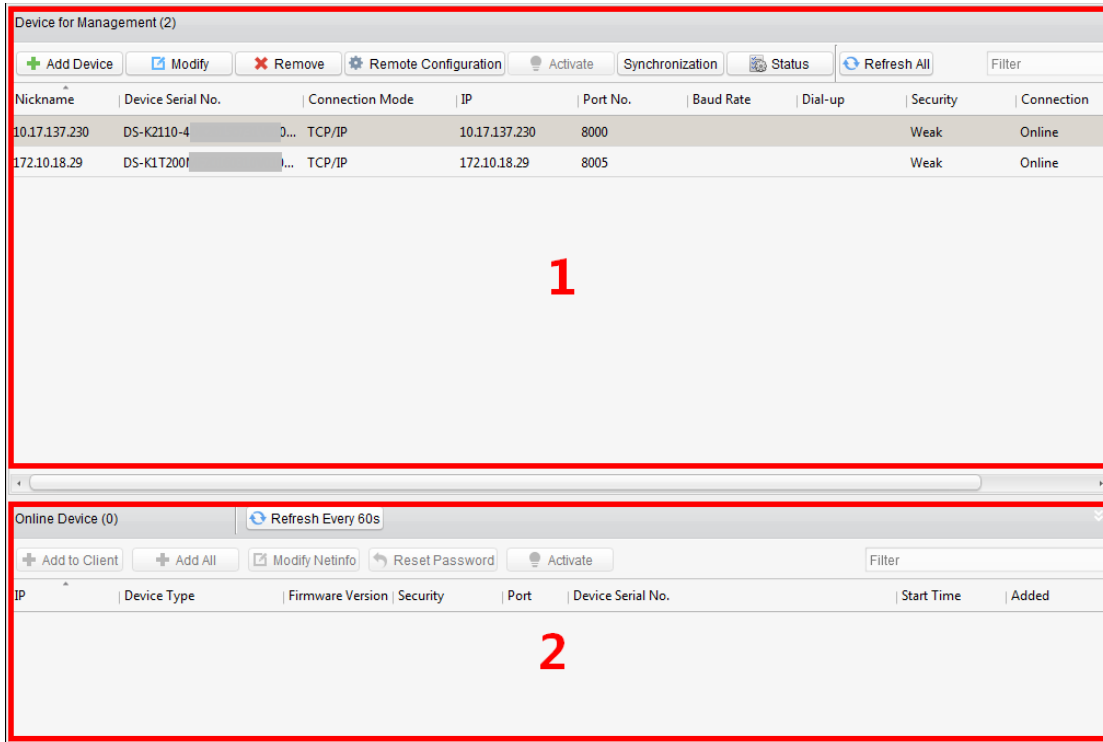

The interface is divided into two parts: Device Management area and Online Device Detection area.

- **Device Management**
Manage the access control devices, including adding, editing, deleting, and batch time synchronizing functions.
- **Online Device Detection**
Automatically detect online devices in the same subnet with the client, and the detected devices can be added to the client in an easy way.

Note: The client can manage up to 16 access control devices and 64 access control points.

Activating Device and Creating Password

Purpose:

If the access control device is not activated, you are required to create the password to activate them before they can be added to the software and work properly.

Steps:

1. On the **Device for Management** or **Online Device** area, check the device status (shown on **Security** column) and select an inactive device.

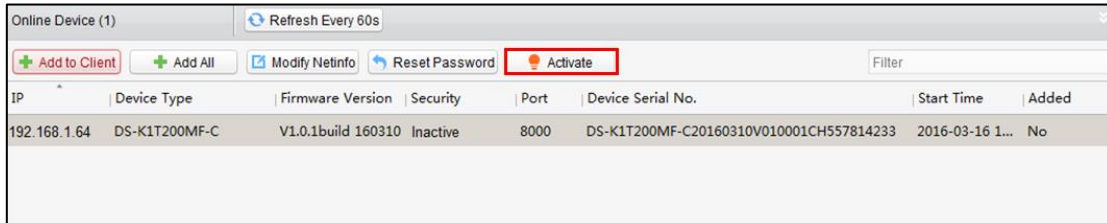

2. Click the **Activate** button to pop up the Activation interface.
3. Create a password in the password field, and confirm the password.



STRONG PASSWORD RECOMMENDED– We highly recommend you create a strong password of your own choosing (using a minimum of 8 characters, including upper case letters, lower case letters, numbers, and special characters) in order to increase the security of your product. And we recommend you reset your password regularly, especially in the high security system, resetting the password monthly or weekly can better protect your product.

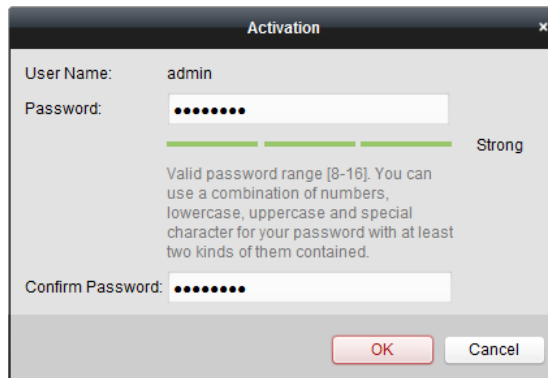

4. Click **OK** to create the password for the device. A “The device is activated.” window pops up when the password is set successfully.
5. Perform the following steps to edit the device’s network parameters.
 - 1) Click **Modify Netinfo** to pop up the Modify Network Parameter interface.

Note: This function is only available on the **Online Device** area. You can change the device IP address to the same subnet with your computer if you need to add the device to the software.
 - 2) Input the password set in step 3 and click **OK** to complete the network settings.

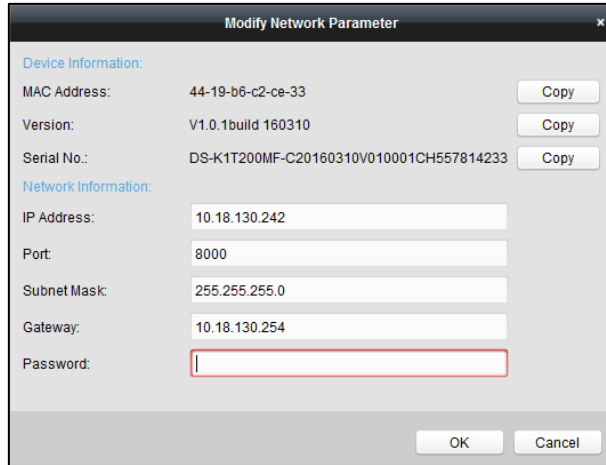

3) Click **OK** to save the settings.

Adding Online Devices

Purpose:

The active online access control devices in the same local subnet with the client will be displayed on the **Online Device** area. You can click the **Refresh Every 60s** button to refresh the information of the online devices.

Note: You can click  to hide the **Online Device** area.

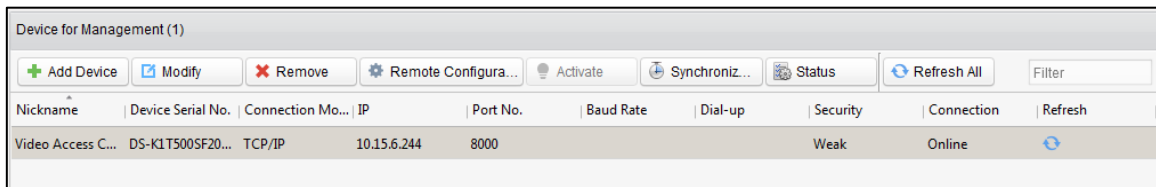

Steps:

1. Select the devices to be added from the list.

Note: For the inactive device, you need to create the password for it before you can add the device properly. For detailed steps, please refer to [3.1.1 Activating Device and Creating Password](#).

2. Click **Add to Client** to open the device adding dialog box.

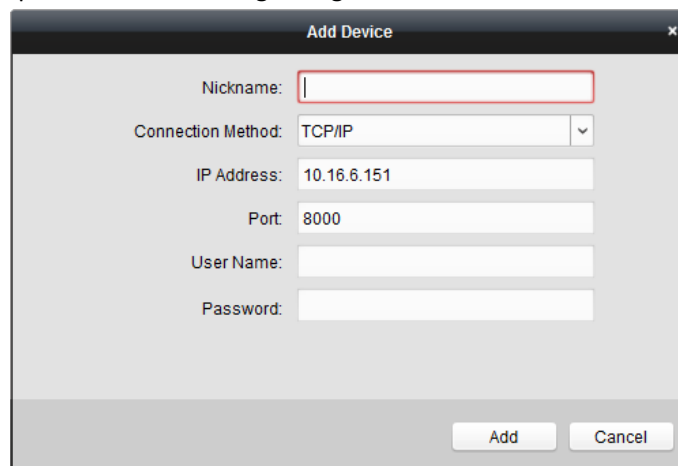

3. Input the required information.

Nickname: Edit a name for the device as you want.

Connection Type: Select TCP/IP as the connection type.

IP Address: Input the device's IP address. The IP address of the device is obtained automatically in this adding mode.

Port: Input the device port No.. The default value is 8000.

User Name: Input the device user name. By default, the user name is *admin*.

Password: Input the device password.

4. Click **Add** to add the device to the client.
5. (Optional) If you want to add multiple online devices to the client software, click and hold *Ctrl* key to select multiple devices, and click **Add to Client** to open the device adding dialog box. In the pop-up message box, enter the user name and password for the devices to be added.
If you want to add all the online devices to the client software, click **Add All** and click **OK** in the pop-up message box. Then enter the user name and password for the devices to be added.
6. You can select the device from the list and click **Reset Password** to reset the device password.

Perform the following steps to reset the device password.

- 1) Click **Export** to save the device file on your PC.
- 2) Send the file to our technical engineers.
- 3) Our technical engineer will send you a file or an eight-digit number to you.
 - If you receive a file from the technical engineer, select **Import File** from Key Importing Mode drop-down list and click  to import the file.
 - If you receive an eight-digit number from the technical engineer, select **Input Key** from Key Importing Mode drop-down list and input the number.
- 4) Input new password in text fields of **Password** and **Confirm Password**.
- 5) Click **OK** to reset the password.



The password strength of the device can be checked by the software. For your privacy, we strongly recommend changing the password to something of your own choosing (using a minimum of 8 characters, including upper case letters, lower case letters, numbers, and special characters) in order to increase the security of your product. And we recommend you reset your password regularly, especially in the high security system, resetting the password monthly or weekly can better protect your product.

Adding Access Control Device Manually

Steps:

1. Click **Add Device** on the Device for Management panel to enter the Add Device interface.

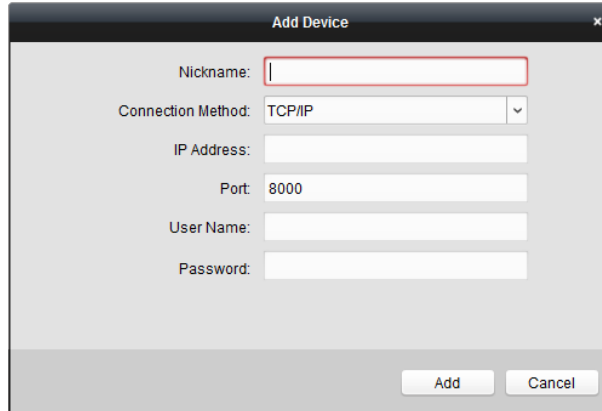

2. Input the device name.
3. Select the connection type in the dropdown list: TCP/IP, COM port (1 to 5), or EHome protocol.
 - TCP/IP:** Connect the device via the network.
 - COM1 to COM5:** Connect the device via the COM port.
 - EHome:** Connect the device via EHome Protocol.

Note: For connection type of EHome protocol, please set the network center parameter first. For details, refer to *3.2.2 Network Center Settings*.
4. Set the parameters of connecting the device.
 - If you select the connection type as TCP/IP, you should input the device **IP Address, Port No., User Name, and Password**.
 - If you select the connection type as COM port, you should input the **Baud Rate** and **Dial-up** value.
 - If you select the connection type as EHome, you should input the **Account**.
5. Click **Add** button to finish adding.

Editing Access Control Device

Purpose:

After adding the device, you can configure the added access control device's parameters, its access control point (door)'s parameters, and its card readers' parameters.

Click to select the added access control device from the list, and then click **Modify** button to enter the Edit Access Controller interface.

Notes:

- After editing the device, you can click **Apply Parameters** to apply the configured parameters to the device to take effect.
- You can also click **Read Parameters** to get the device parameters from the device itself.

Editing Basic Information

You can configure the device basic information including IP address, port No., etc.

Steps:

1. In the device list on the left, select the access control device and you can edit its basic parameters on your demand, which are the same as the ones when adding the device.

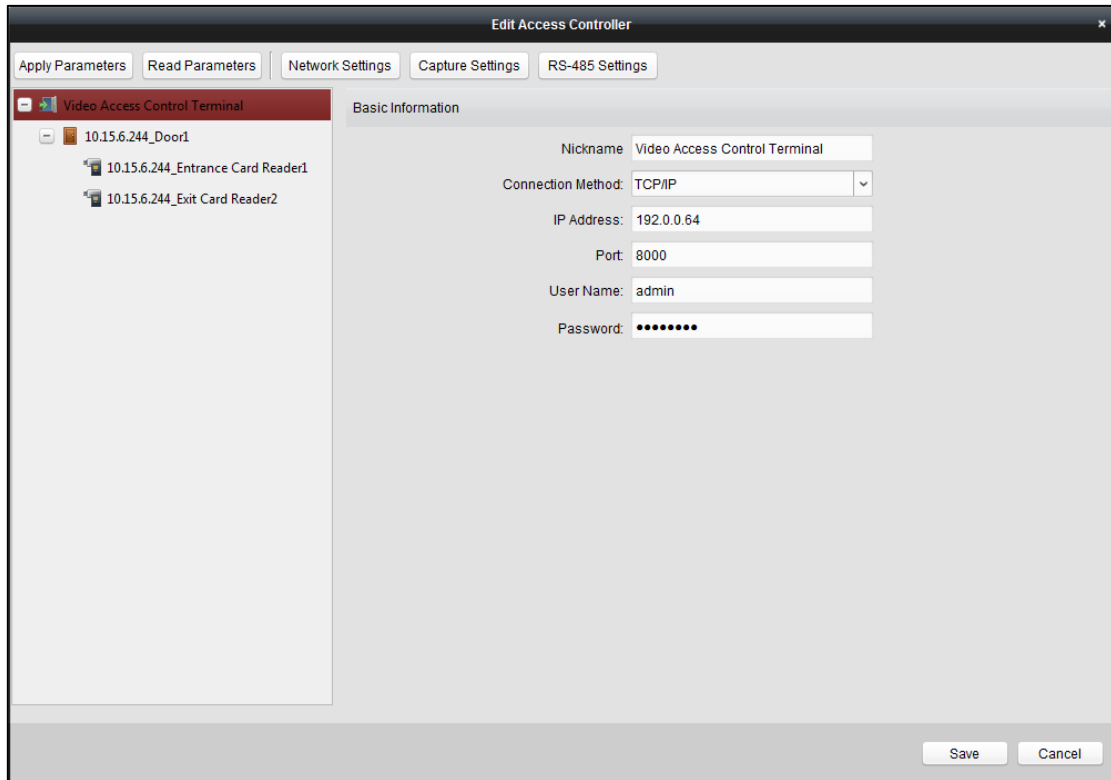

2. Click **Save** button to save the settings.
3. You can click **Apply Parameters** button to apply the updated parameters to the local memory of the device.

Editing Door Information

Steps:

1. In the device list on the left, click  to expand the access control device, select the door (access control point) and you can edit the information of the selected door on the right.

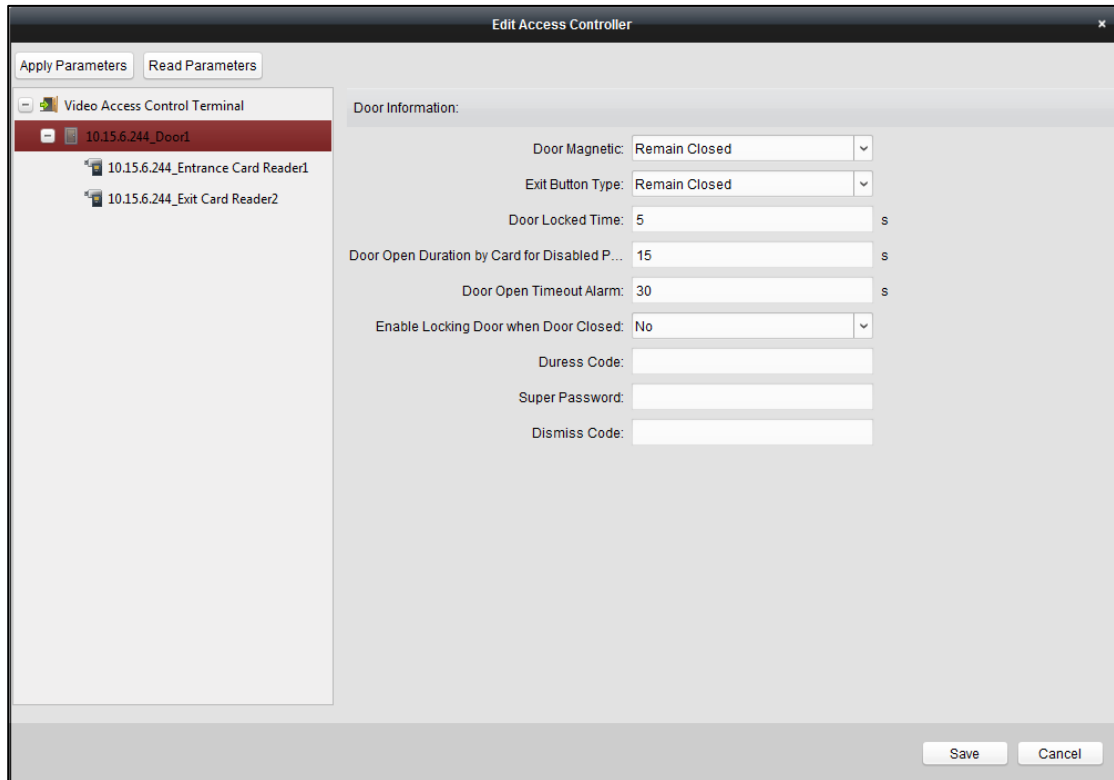

2. You can editing the following parameters:

Door Magnetic: The Door Magnetic is in the status of **Normal Closed** (excluding special conditions).

Exit Button Type: The Exit Button Type is in the status of **Remain Open** (excluding special conditions).

Door Locked Time: After swiping the normal card and relay action, the timer for locking the door starts working.

Door Open Duration by Card for Door Extended Opening: The door magnetic can be enabled with appropriate delay after card holder swipes the card.

Door Open Timeout Alarm: The alarm can be triggered if the door has not been close

Enable Locking Door when Door Closed: The door can be locked once it is closed even if the Door Locked Time is not reached.

Duress Code: The door can open by inputting the duress code when there is duress. At the same time, the client can report the duress event.

Super Password: The specific person can open the door by inputting the super password.

Dismiss Code: Input the dismiss code to stop the buzzer of the card reader.

Note: The Duress Code, Super Code, and Dismiss Code should be different.

3. Click **Save** button to save parameters.
4. Click **Apply Parameters** button to apply the updated parameters to the local memory of the device.

Editing Card Reader Information

Steps:

1. In the device list on the left, click  to expand the door, select the card reader name and you can edit the card reader information on the right.

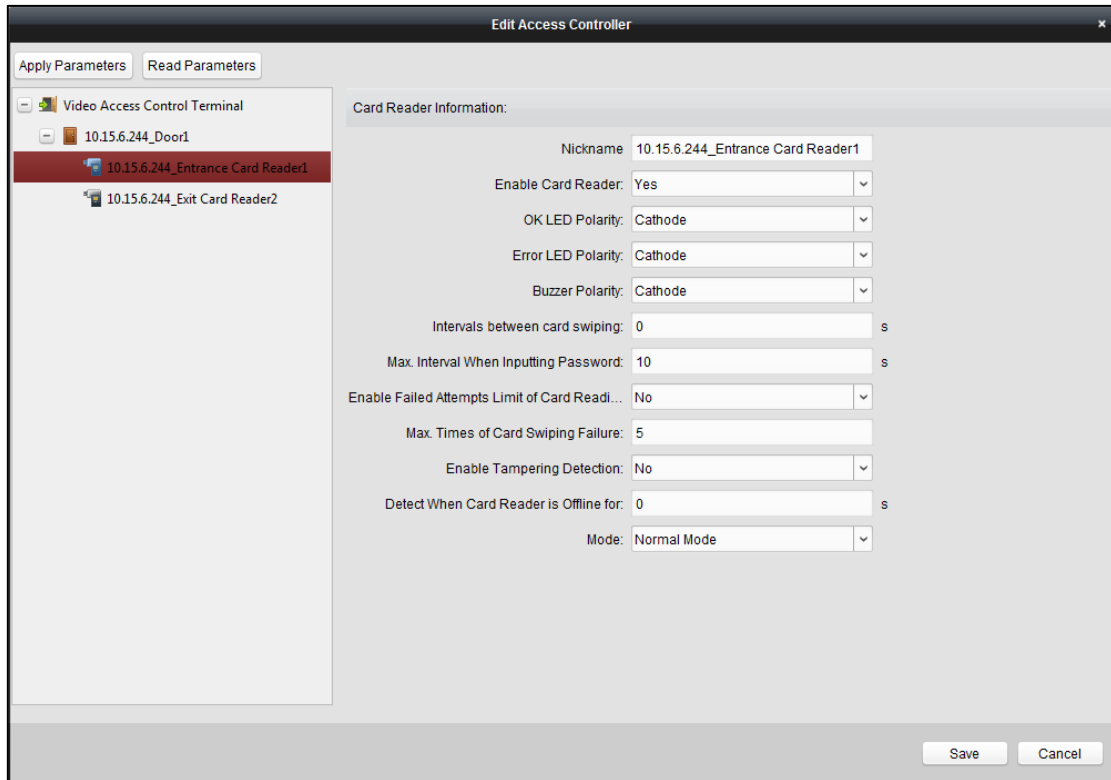

2. You can editing the following parameters:

Enable Card Reader: Select **Yes** to enable the card reader.

OK LED Polarity: Select the OK LED Polarity of the card reader mainboard.

Error LED Polarity: Select the Error LED Polarity of the card reader mainboard

Buzzer Polarity: Select the Buzzer LED Polarity of the card reader mainboard

Interval between Card Swiping: If the interval between card swiping of the same card is less than the set value, the card swiping is invalid. You can set it as 0 to 255.

Max. Interval When Inputting Password: When you inputting the password on the card reader, if the interval between pressing two digits is larger than the set value, the digits you pressed before will be cleared automatically.

Enable Failed Attempts Limit of Card Reading: Enable to report alarm when the card reading attempts reach the set value.

Max. Times of Card Swiping Failure: Set the max. failure attempts of reading card.

Enable Tampering Detection: Enable the anti-tamper detection for the card reader.

Detect When Card Reader is Offline for: When the access control device cannot connect with the card reader for longer than the set time, the card reader will turn offline automatically.

Mode: Select the card reader mode as normal mode (reading card) or issuing card mode (getting the card No.).

3. Click the **Save** button to save parameters.

4. Click **Apply Parameters** button to apply the updated parameters to the local memory of the device.

Deleting Device

Steps:

1. In the device list, click to select a single device, or select multiple devices by pressing *Ctrl* button on your keyboard and clicking them one by one.
2. Click **Remove** button to delete the selected device(s).
3. Click **OK** button in the pop-up confirmation dialog to finish deleting.

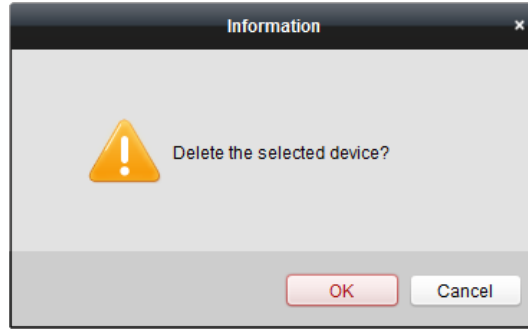

Time Synchronization

Steps:

1. In the device list, click to select a single device, or select multiple devices by pressing *Ctrl* button on your keyboard and clicking them one by one.
2. Click **Synchronization** button to start time synchronization.
A message box will pop up on the lower-right corner of the screen when the time synchronization is completed.

Viewing Device Status

In the device list, you can select the device and then click **Status** button to enter view its status.

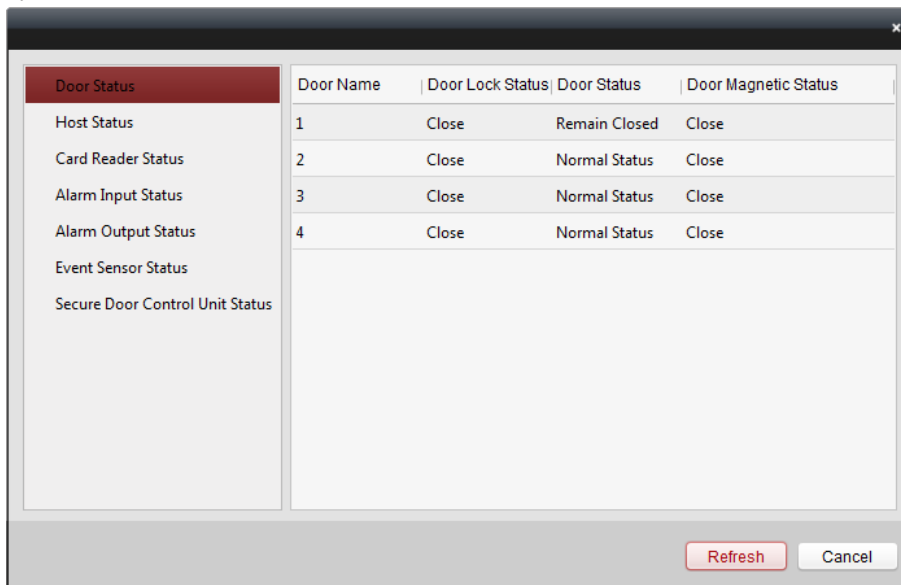

Door Status: The status of the connected door.

Host Status: The status of the host, including Storage Battery Power Voltage, Device Power Supply Status, Multi-door Interlocking Status, Anti-passing Back Status, and Host Anti-Tamper Status.

Card Reader Status: The status of card reader.

Alarm Input Status: The alarm input status of each port.

Alarm Output Status: The alarm output status of each port.

Event Sensor Status: The event status of each port.

Secure Door Control Unit Status: The online status and tamper status of the Secure Door Control Unit.

Remote Configuration

Purpose:

In the device list, select the device and click **Remote Configuration** button to enter the remote configuration interface. You can set the detailed parameters of the selected device.

Checking Device Information

Steps:

1. In the device list, you can click **Remote Configuration** to enter the remote configuration interface.
2. Click **System** -> **Device Information** to check the device basic information and the device version information.

Displaying the Device Information

Basic Information

Device Type: <input type="text" value="DS-K1T500SF"/>	Local RS-485 Number: <input type="text" value="1"/>
Local Zone Number: <input type="text" value="0"/>	Extended RS-485 Number: <input type="text" value="0"/>
Extended Zone Number: <input type="text" value="0"/>	Sub-system Number: <input type="text" value="0"/>
Local Trigger Number: <input type="text" value="1"/>	Public Sub-system Num...: <input type="text" value="0"/>
Extended Trigger Number: <input type="text" value="0"/>	Keyboard Number: <input type="text" value="0"/>
Local Sensor Number: <input type="text" value="0"/>	Global Keyboard Number: <input type="text" value="0"/>
Extended Sensor Number: <input type="text" value="0"/>	Analog Camera Number: <input type="text" value="1"/>
Siren Number: <input type="text" value="0"/>	Network User Number: <input type="text" value="1"/>
Electric Lock Number: <input type="text" value="1"/>	Mobile Gate Number: <input type="text" value="0"/>
Device Serial No.: <input type="text" value="DS-K1T500SF20161213V010100EN664901567"/>	

Version Information

Firmware Version:	V1.1.0 build 161213
Hardware Version:	0x10001

Editing Device Name

In the Remote Configuration interface, click **System** -> **General** to configure the device name and overwrite record files parameter. Click **Save** to save the settings.

Configuring the General Parameters

Device Information

Device Name:	<input type="text" value="Access Controller"/>
Overwrite Record Files:	<input type="text" value="No"/> ▼
<input type="button" value="Save"/>	

Editing Time

Steps:

1. In the Remote Configuration interface, click **System** -> **Time** to configure the time zone.
2. (Optional) Check **Enable NTP** and configure the NTP server address, the NTP port, and the synchronization interval.
3. (Optional) Check **Enable DST** and configure the DST star time, end time and the bias.

- Click **Save** to save the settings.

Configuring the Time Settings (e.g., NTP, DST)

Time Zone

Select Time Zone: (GMT+08:00) Beijing, Hong Kong, Perth, Singa... ▼

Enable NTP

Server Address:

NTP Port:

Sync Interval: Minute(s)

Enable DST

Start Time: April ▼ First Week ▼ Sun ▼ 2 ▲▼ : 00

End Time: October ▼ Last Week ▼ Sun ▼ 2 ▲▼ : 00

DST Bias: 60 min ▼

System Maintenance Settings

Steps:

- In the Remote Configuration interface, click **System** -> **System Maintenance**.
- Click **Reboot** to reboot the device.
Or click **Restore Default Settings** to restore the device settings to the default ones, excluding the IP address.
Or click **Restore All** to restore the device parameters to the default ones. The device should be activated after restoring.
Or click **Import Configuration File** to import the configuration file from the local PC to the device.
Or click **Export Configuration File** to export the configuration file from the device to the local PC.

NOTE

The configuration file contains the device parameters.

- In the Remote Upgrade part, select a upgrade file type in the dropdown list. Click  to select the upgrade file. Click **Upgrade** to start upgrading.
You are able to select Controller Upgrade File, Card Reader Upgrade File and Distributed Controller Upgrade File in the drop-down list.

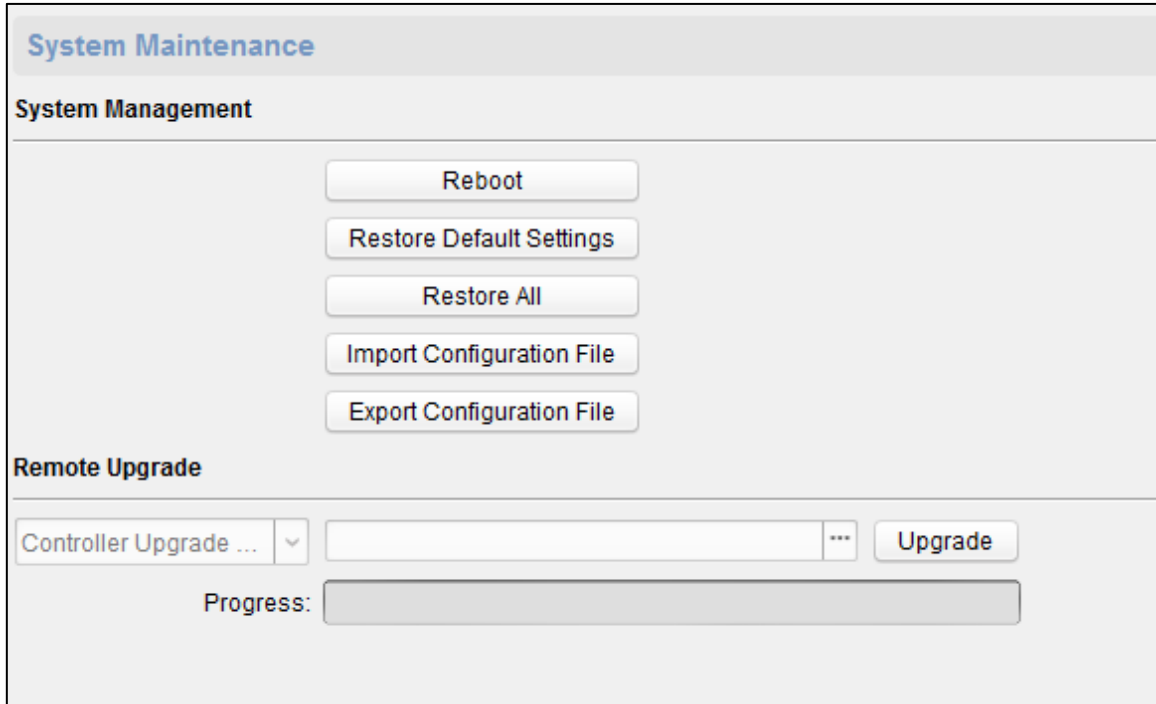

Managing User

Steps:

1. In the Remote Configuration interface, click **System** -> **User**.

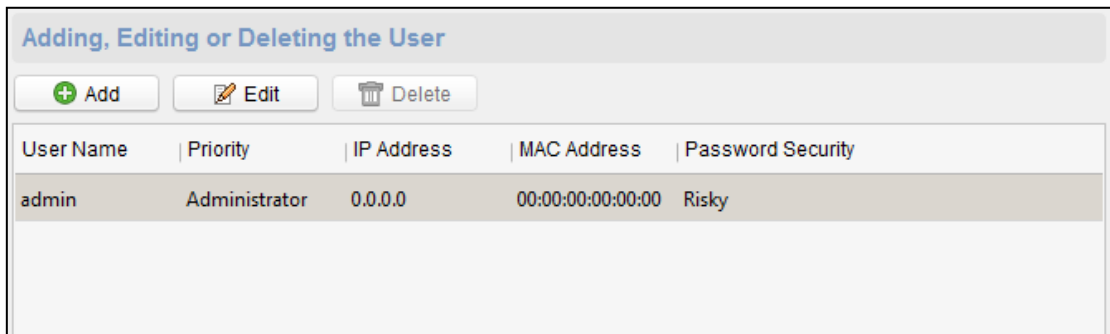

2. Click **Add** to add the user (Do not support by the elevator controller.).
Or select a user in the user list and click **Edit** to edit the user. You are able to edit the user password, the IP address, the MAC address and the user permission. Click **OK** to confirm editing.

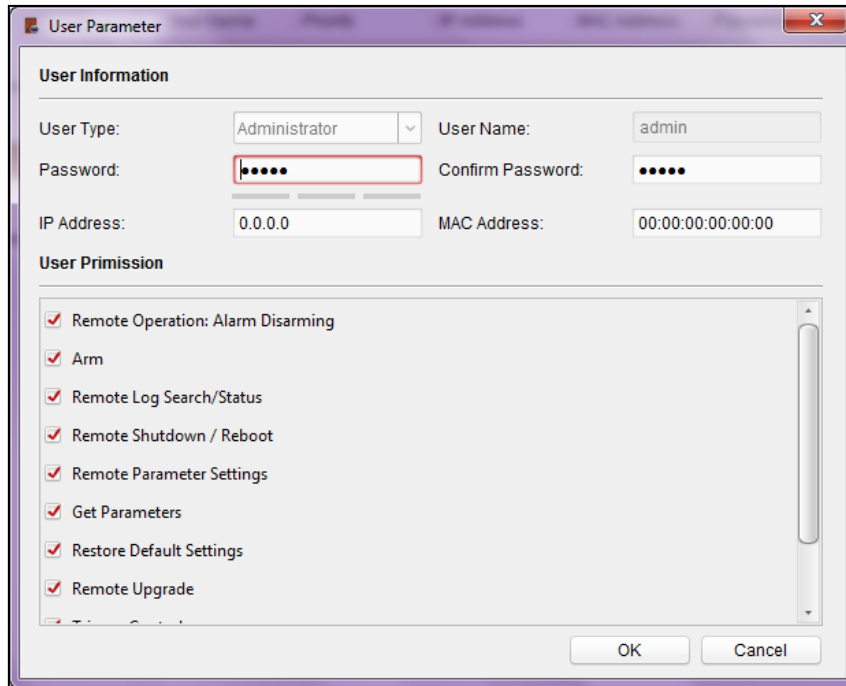

Setting Security

Steps:

1. Click **System** -> **Security**.

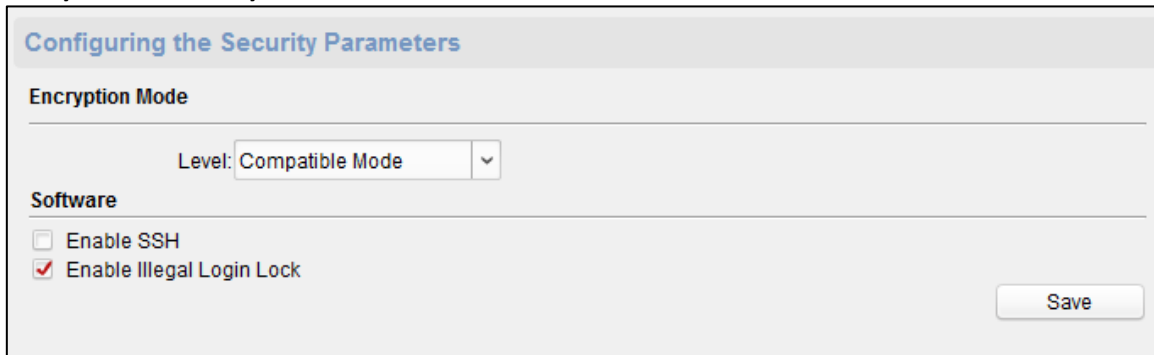

2. Select the encryption mode in the dropdown list. You are able to select Compatible Mode or Encryption Mode.
3. (Optional) You can check **Enable SSH** or **Enable Illegal Login Lock** in the Software part.
4. Click **Save** to save the settings.

Configuring Network Parameters

Click **Network** -> **General**. You can configure the NIC type, the IPv4 address, the subnet mask (IPv4), the default gateway (IPv4), MTU address, the MTU, and the device port. Click **Save** to save the settings.

Configuring the Network Parameters

NIC Type: 10M/100M/1000M Self... ▾

IPv4 Address: 10.15.6.244

Subnet Mask (IPv4): 255.255.255.0

Default Gateway (IPv4): 10.15.6.254

MAC Address: 44:19:b6:c8:0d:21

MTU(Byte): 1500

Device Port: 8000

Save

Configuring Upload Method

Steps:

1. Click **Network** -> **Uploading Method Settings**.

Configuring the Upload Method

Center Group Parameters

Center Group: Center Group1 ▾

Enable

Uploading Method Config...

Main Channel	Backup Chann...	Backup Chann...	Backup Channel 3
Close ▾	Close ▾	Close ▾	Close ▾

Save

2. Select a Center Group from the drop-down list.
3. Check the **Enable** check box and set the uploading method.
4. Click **Save** to save the settings.

Configuring Network Center Parameters

Click **Network** -> **Network Center Settings**. You can set the notify surveillance center, the IP address, the port No. the protocol type and the user name. Click **Save** to save these settings.

The screenshot shows a dialog box titled "Configuring the Network Center Parameters". It contains the following fields and controls:

- Notify Surveillance Center: Network Center1 (dropdown menu)
- IP Address: 0.0.0.0 (text input)
- Port: 0 (text input)
- Protocol Type: (empty dropdown menu)
- User Name: (empty text input)
- Save (button)

Configuring Advanced Network

Click **Network** -> **Advanced Settings**. You can configure the DNS address 1, the DNS address 2, the alarm host IP and the alarm host port. Click **Save** to save the settings.

The screenshot shows a dialog box titled "Configuring the Advanced Network Settings". It contains the following fields and controls:

- DNS Server Address1: 0.0.0.0 (text input)
- DNS Server Address2: 0.0.0.0 (text input)
- Alarm Host IP: 0.0.0.0 (text input)
- Alarm Host Port: 0 (text input)
- Save (button)

Configuring Wi-Fi Parameter

Step:

1. Click **Network** -> **Wi-Fi**.

Configure Wi-Fi parameters

Enable

Hot Spot Name:

Password:

Display Password

Encryption Mode:

Connect Status: Not Connect Fail Reason: Unknown Error

NIC Type:

Enable DHCP:

IP Address:

Subnet Mask:

Default Gateway:

MAC Address:

DNS1 IP Address:

DNS2 IP Address:

2. Check the **Enable** checkbox to enable the Wi-Fi function.
You can set the hot spot name and the password. Click **Select** to select the hot spot. Click **Refresh** to refresh the Wi-Fi status.
You can also set the NIC type.
Check the **Enable DHCP** checkbox to auto allocate the IP address, the subnet mask, the default gateway, the MAC address the DNS1 IP address and the DNS2 IP address.
3. Click **Save** to save the settings.

Configuring Wireless Dial Status

Steps:

1. Click **Network** -> **Wireless Dial**.

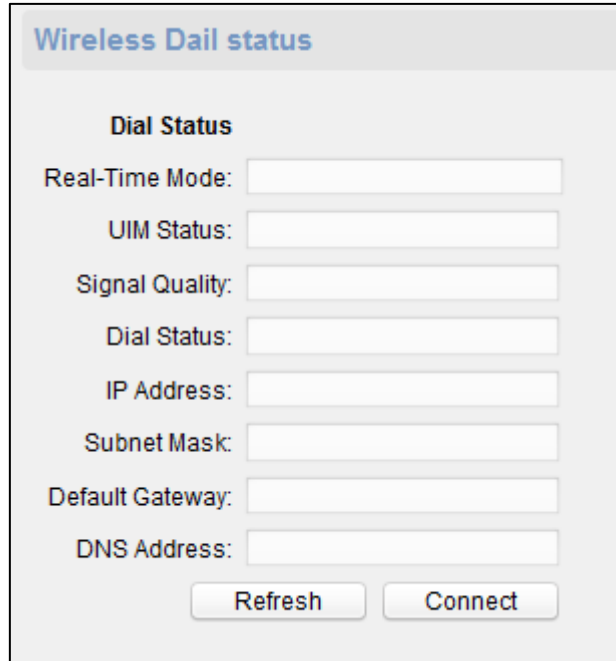

Wireless Dial status

Dial Status

Real-Time Mode:

UIM Status:

Signal Quality:

Dial Status:

IP Address:

Subnet Mask:

Default Gateway:

DNS Address:

2. Edit the dial status, including the real-time mode, the UIM status, the signal quality, the dial status, the IP address, the subnet mask the default gateway and the DNS address.
3. Click **Conenct** to start connecting.
Or click **Refresh** to refresh the status.

Configuring HDD Parameters

Steps:

1. Click **Storage** -> **General**.

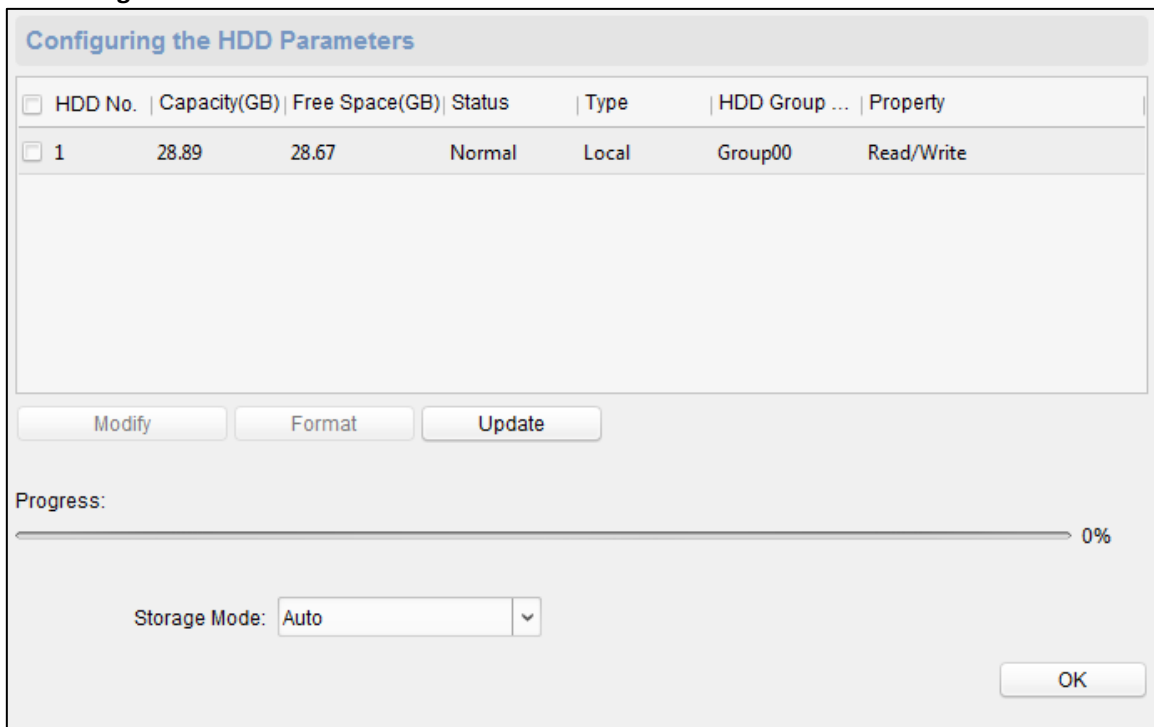

Configuring the HDD Parameters

<input type="checkbox"/>	HDD No.	Capacity(GB)	Free Space(GB)	Status	Type	HDD Group ...	Property
<input type="checkbox"/>	1	28.89	28.67	Normal	Local	Group00	Read/Write

Progress:

Storage Mode:

2. Check the HDD (SD card) No., capacity, the free space, the status and so on.
You can also edit and format the HDD (SD card). Or click **Update** to refresh the data.

3. Select the storage mode.
4. Click **Save** to save the settings.

Configuring Trigger Parameters

Steps:

1. Click **Alarm** -> **Trigger**. You can check the trigger parameters.

Configuring the Trigger Parameters			
Trigger	Name	Output Delay(s)	Settings
1		0	
2		0	

2. Click the icon  to enter the Trigger Parameters Settings window. You can configure the trigger name and the output delay.
3. Click **Save** to save the paramters.
4. (Optional) Click **Copy to...** to copy the trigger information to other triggers.

Trigger Parameters Settings ✕

Trigger:

Name:

Output Delay(s):

Configuring Access Control

In the Remote Configuration interface, click **Other** -> **Access Control Parameters**. Check **Superimposed user information**, **Enable voice prompts**, **Upload picture to capture whether the linkage**, **Save Linked Captured Pictures**, **Whether to allow key input card number**, **Enable WiFi detect**, and **Enable 3G/4G**. Click **Save** to save the settings.

Configuring the Access Control

Superimposed User Information

Enable Voice Prompts

Upload Picture for Linkage Capture

Save Linked Caputuring Picture

Press Keyboard to Enter Card No.

Enable Wi-Fi Probe

Enable 3G/4G

Uploading Backgroup Picture

Click **Other** -> **Picture Upload**. Click  to select the picture from the local. You can also click **Live View** to preview the picture. Click **Picture Upload** to upload the picture.

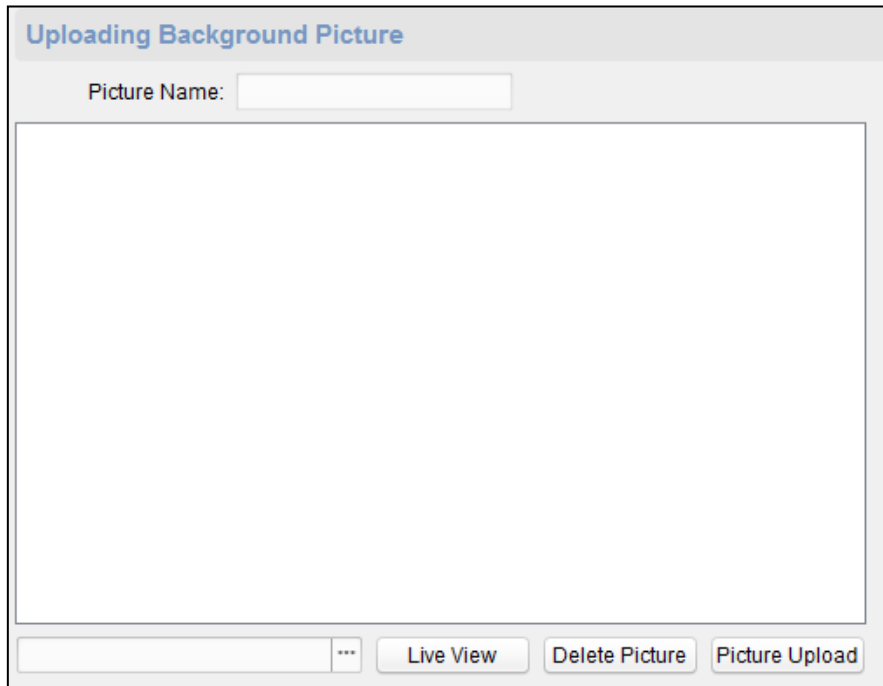

Configuring Face Detection Parameters

Click **Other** -> **Face Detection**. You can check the **Enable** checkbox to enable the device face detection function.

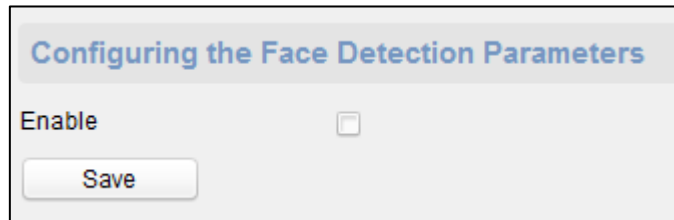

Configuring Video and Audio Parameters

You can set the video compression parameters.

Steps:

1. Click **Image** -> **Video & Audio**.

Configuring the Image Quality, Resolution and Other Parameters of the Camera

Camera: ▼

Video

Stream Type: <input type="text" value="Main Stream"/> ▼	Video Type: <input type="text" value="Video & Audio"/> ▼
Bitrate Type: <input type="text" value="Constant"/> ▼	Bitrate: <input type="text" value="2048 Kbps"/> ▼
Video Quality: <input type="text" value="Medium"/> ▼	Resolution: <input type="text" value="1080P(1920*1080)"/> ▼
Frame Type: <input type="text" value="P"/> ▼	Frame Rate: <input type="text" value="25fps"/> ▼
I Frame Interval: <input type="text" value="25"/> ▲▼	Audio Encoding Type: <input type="text" value="G711_U"/> ▼
Video Encoding Type: <input type="text" value="STD_H264"/> ▼	
File Size Per Day: 21.0G	

2. Select a camera in the drop-down list.
3. Set the camera video parameters, including the stream type, the bitrate type, the video quality, the frame type, the I frame type, the video encoding type, the video type, the bitrate, the resolution, the frame rate and the audio encoding type.
4. Click **Save** to save the settings.
Or click **Copy to...** to copy the parameters to other cameras.

Configuring Video Image Parameters

You can set the camera mode, brightness, contrast, saturation, hue, and sharpness.

Steps:

1. Click **Image** -> **Image Settings**.

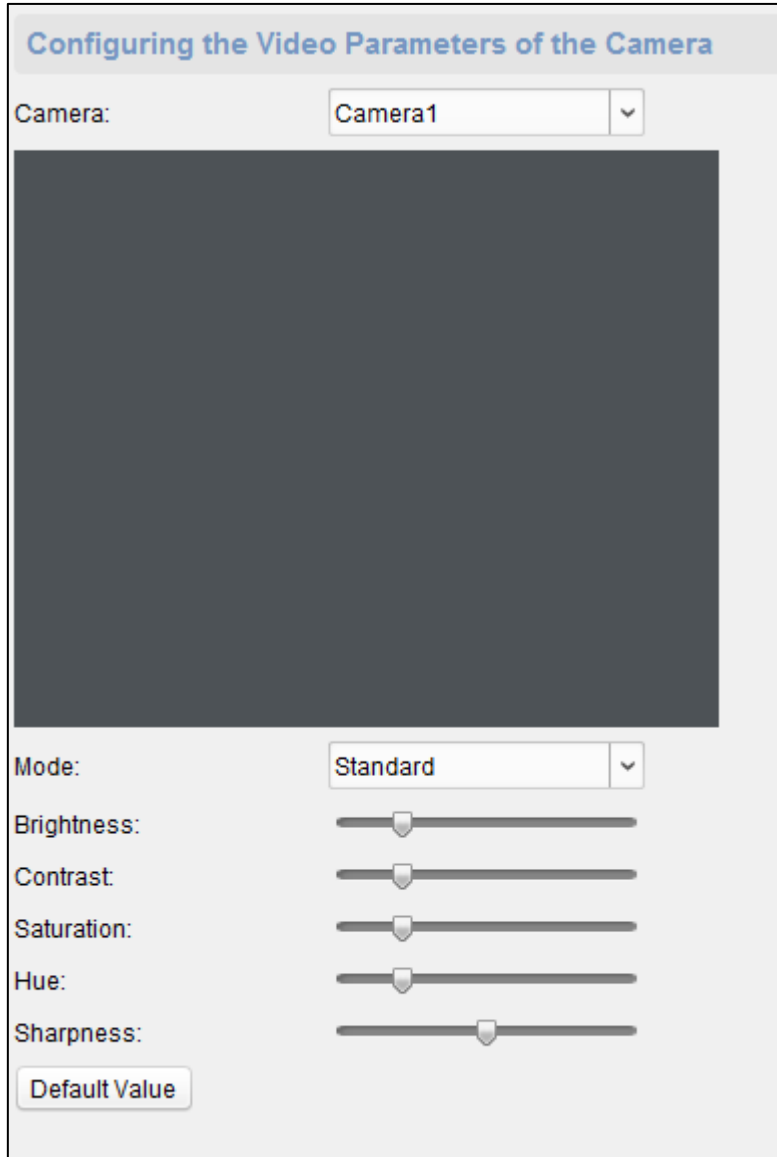

2. Select a camera in the dropdown list.
3. Set the camera mode, brightness, contrast, saturation, hue, and sharpness.
Or click **Default Value** to set the parameters to the default values.

Configuring Volume Input and Output

Click **Image** -> **Volume Input/Output**. You can set the volume input and output. Click **Save** to save the settings.

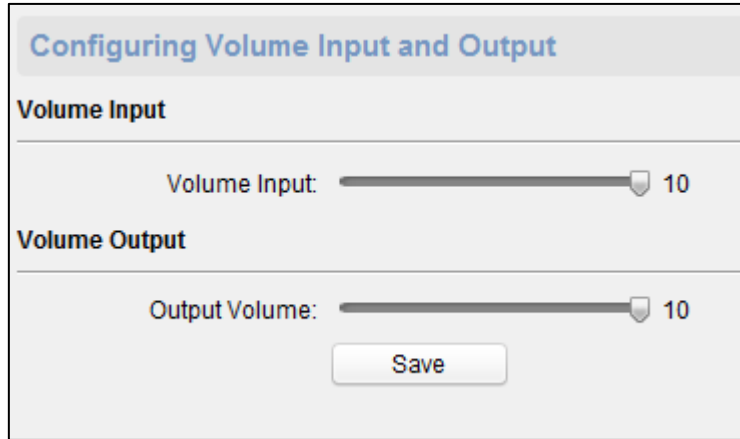

Operating Trigger

Steps:

1. Click **Operation** -> **Trigger**. You can check the trigger status.
2. Check the trigger and click **Open** or **Close** to open/close the trigger.

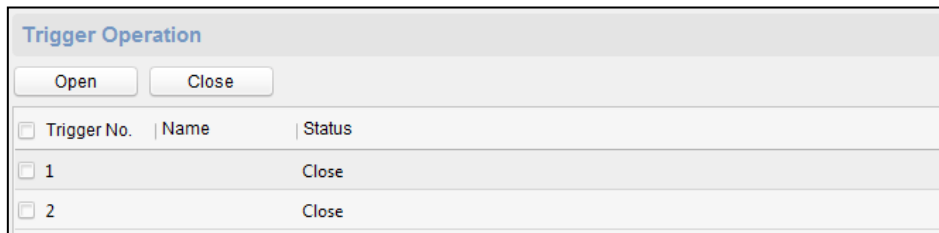

Checking Status

Click **Status** -> **Alarm** or **Status** -> **Trigger** to check the trigger status.

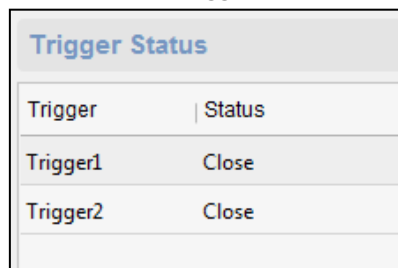

7.2.2 Network Settings

In the Edit Access Controller interface, select the access control device and click **Network Settings** button to enter the Network Settings interface. You can set the uploading mode, and set the network center and wireless communication center.

Uploading Mode Settings

Steps:

1. Click the **Uploading Mode Settings** tab.

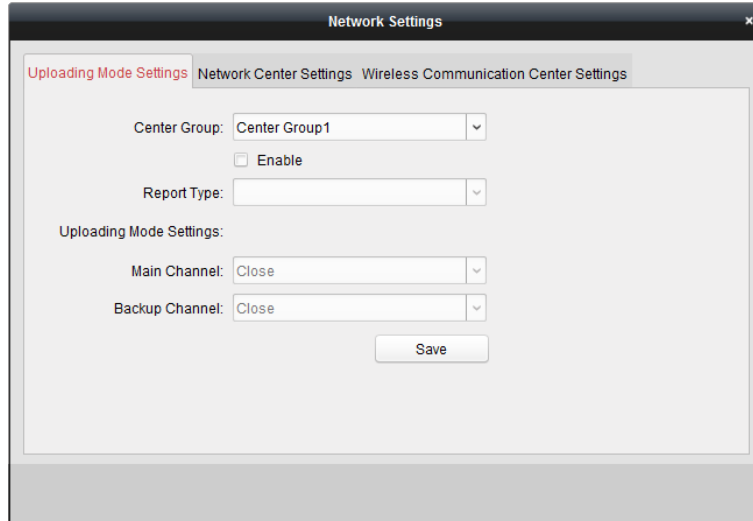

2. Select the center group in the dropdown list.
 3. Check the **Enable** checkbox to enable the selected center group.
 4. Select the report type in the dropdown list.
 5. Select the uploading mode in the dropdown list. You can enable N1/G1 for the main channel and the backup channel, or select off to disable the main channel or the backup channel.
- Note:** The main channel and the backup channel cannot enable N1 or G1 at the same time.
6. Click **Save** button to save parameters.

Network Center Settings

You can set the account for EHome protocol in Network Settings tab page. Then you can add devices via EHome protocol.

Steps:

1. Click the **Network Center Settings** tab.

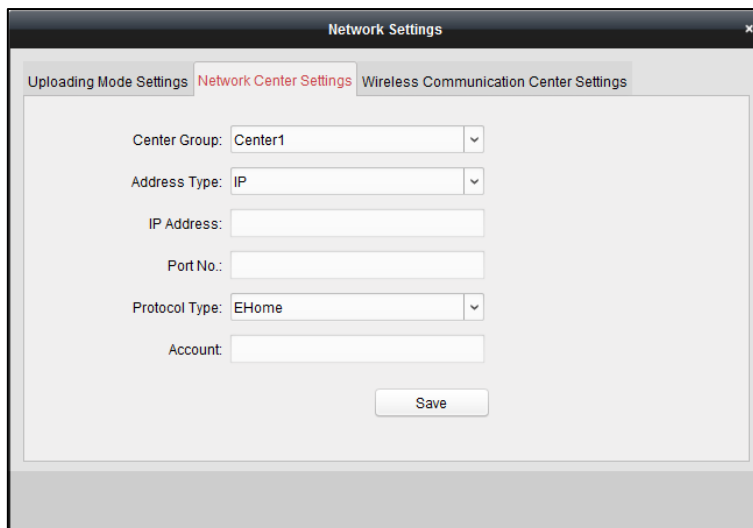

2. Select the center group in the dropdown list.
 3. Select an address type in the dropdown list.
 4. Input IP address and port No. For EHome protocol, the default port No. for EHome is 7660.
 5. Select the protocol type as EHome.
 6. Set an account name for the network center.
- Note:** The account should contain 1 to 32 characters and only letters and numbers are allowed.
7. Click **Save** button to save parameters.

Note: The port number of the wireless network and wired network should be consistent with the port number of EHome.

Wireless Communication Center Settings

Steps:

1. Click the **Wireless Communication Center Settings** tab.

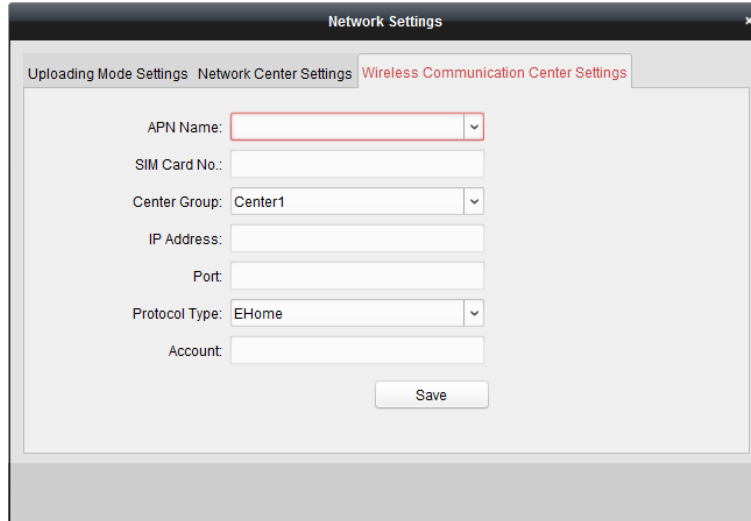

2. Select the APN name as CMNET or UNINET.
3. Input the SIM Card No.
4. Select the center group in the dropdown list.
5. Input the IP address and Port No.
6. Select the protocol type as EHome. The default port No. for EHome is 7660.
7. Set an account name for the network center. A consistent account should be used in one platform.
8. Click **Save** button to save parameters.

Note: The port number of the wireless network and wired network should be consistent with the port number of EHome.

7.2.3 Capture Settings

In the Edit Access Controller interface, select the access control device and click **Capture Settings** button to enter the capture settings interface. You can set the parameters of capture linkage and manual capture.

Notes:

- The **Capture Settings** should be supported by the device.
- Before setting the capture setting, you should configure the storage server for picture storage. For details, refer to *8.4.4 Storage Server Configuration*.

Linked Capture

Steps:

1. Select the **Linked Capture** tab.

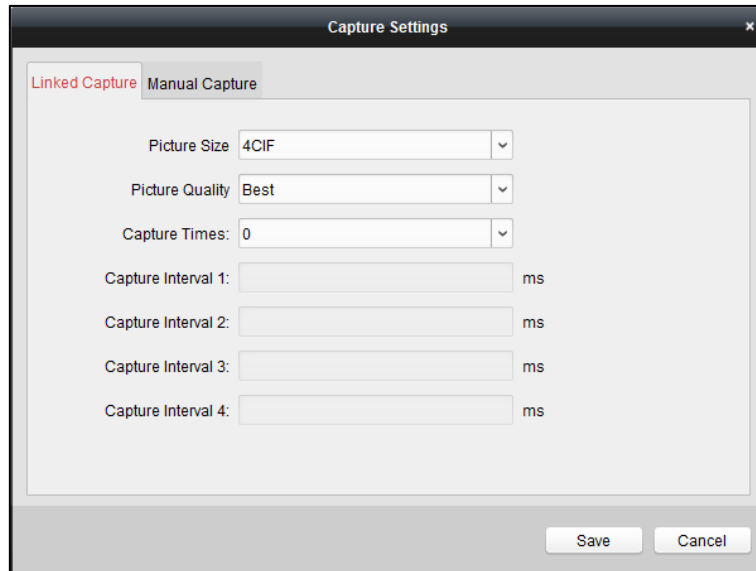

2. Set the picture size and quality.
Set the linked capture times once triggered
Set the capture interval according to the capture times.
3. Click **Save** to save the settings.

Manual Capture

Steps:

1. Select the **Manual Capture** tab.

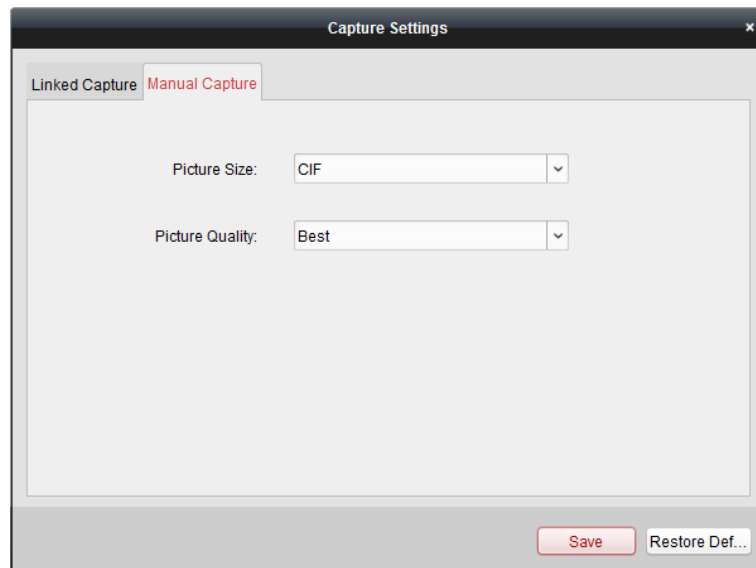

2. Select the resolution of the captured pictures from the dropdown list.
Note: The supported resolution types are CIF, QCIF, 4CIF/D1, SVGA, HD720P, VGA, WD1, and AUTO.
3. Select the picture quality as Best, Better, or Normal.
4. Click **Save** to save the settings.
5. You can click **Restore Default Value** to restore the parameters to default settings.

7.2.4 RS-485 Settings

Purpose:

You can set the RS-485 parameters including the baud rate, data bit, the stop bit, parity type, flow control type, communication mode, work mode, and connection mode.

Note: The RS-485 Settings should be supported by the device.

Steps:

1. In the Edit Access Controller interface, select the access control device and click the **RS-485 Settings** button to enter the RS-485 Settings interface.
- Note:** The **RS-485 Settings** button is available when the device supports RS-485 port.
2. Select the serial No. of the port from the dropdown list to set the RS-485 parameters.
3. Set the baud rate, data bit, the stop bit, parity type, communication mode, work mode, and connection mode in the dropdown list.
4. Click **Save** to save the settings and the configured parameters will be applied to the device automatically.

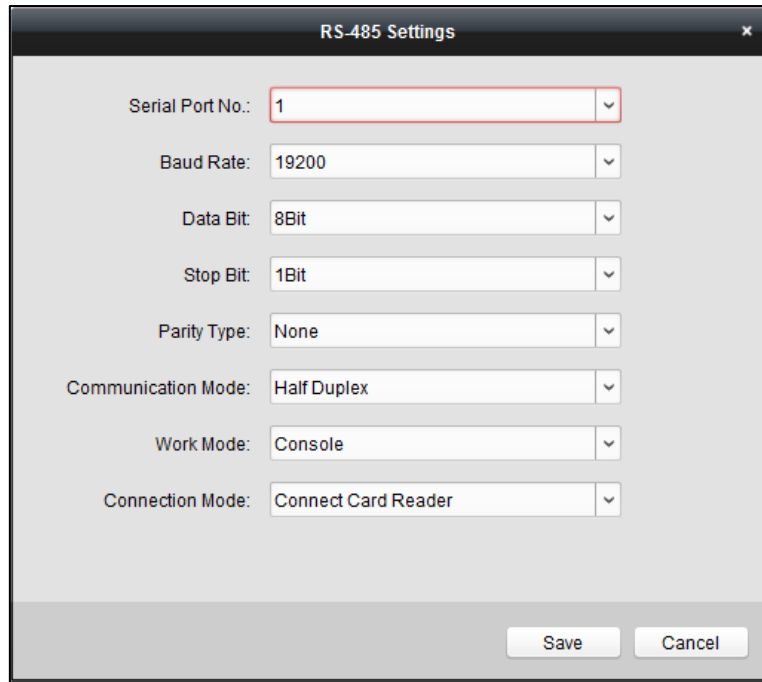

7.2.5 Door Group Management

After adding the access control device, you can add the access control points (doors) to different groups to realize the centralized management.



Click [Door Group Management](#) icon on the control panel to enter the Door Group Management interface.

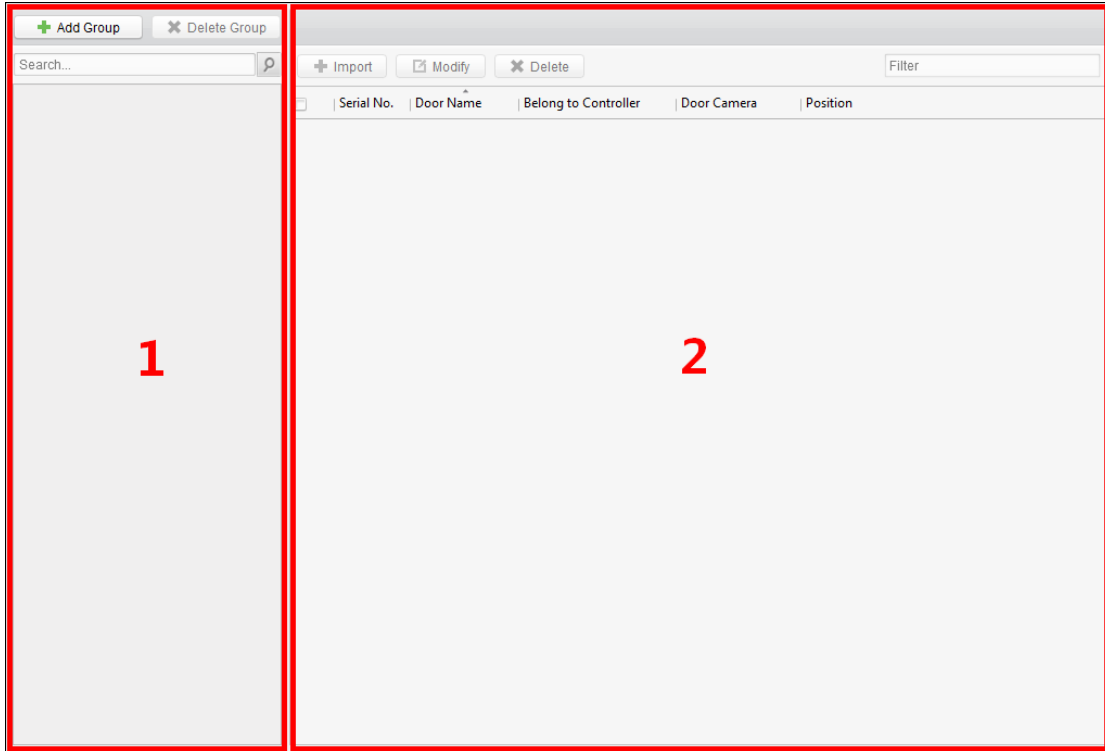

The interface is divided into two parts: Group Management area and Access Control Point Management area.

- **Group Management**
The access control points can be added to different groups to realize the centralized management.
- **Access Control Point Management**
Manage the specific access control point (door) under the group, including importing, editing and deleting access control point.

Access Control Group Management

Adding Group

Before you can manage the doors, you need to create groups first.

Steps:

1. Click **Add Group** button on the left to pop up the Add Group dialog.

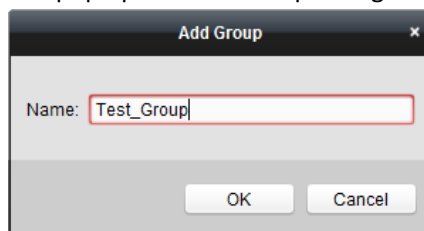

2. Input the group name in the text field and click **OK** button to finish adding.

Editing Group

After adding the group, you can move the mouse to the group name and click  to pop up the Edit Group dialog box.

Or you can double click the group to edit the group name.

Deleting Group

You can move the mouse to the group name and click  to delete the selected group.

Or you can click to select the group and click **Delete Group** to delete it.

Note: All the access control points in the group will be deleted.

Access Control Point (Door) Management

After adding the group, you can import the access control point of the added access control device to the group.

Importing Access Control Point

Steps:

1. Select the added group, and click **Import** button to pop up the access control point importing interface as follows.

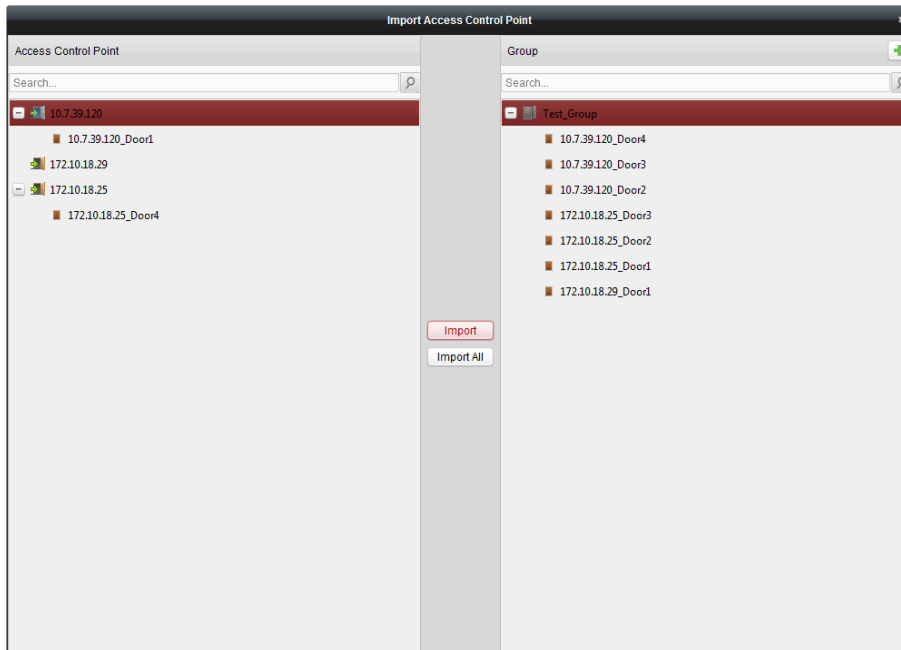

2. Select the access control point to import from the access control point list on the left.
3. Select an added group to import the access control point on the right.
4. Click **Import** button to import the selected access control points or you can click **Import All** to import all the available access control points to the selected group.
5. (Optional) You can click button on the upper-right corner of the window to create a new group. Move the mouse to the added group or access control point and click or to edit or delete it.

Note: Up to 64 access control points can be imported to the door group.

Editing Access Control Point

Steps:

1. Check the checkbox to select the imported access control point in the list and click **Edit** button to edit the access control point.
2. You can edit the access control point name and the position.
3. You can view the card reader under the selected access control point.
4. Click **OK** to save the settings.

Deleting Access Control Point

Check the checkbox to select the imported access control point and click **Delete** button to delete the selected access control point.

7.3 Permission Configuration

You can add the department and person to the client for management, and add card for access control. You can set the schedule template and configure the access control permission via the client.

7.3.1 Person Management



Click **Person Management** icon on the control panel to enter the Person Management interface.

You can add, edit, and delete the department and person in Person Management module.

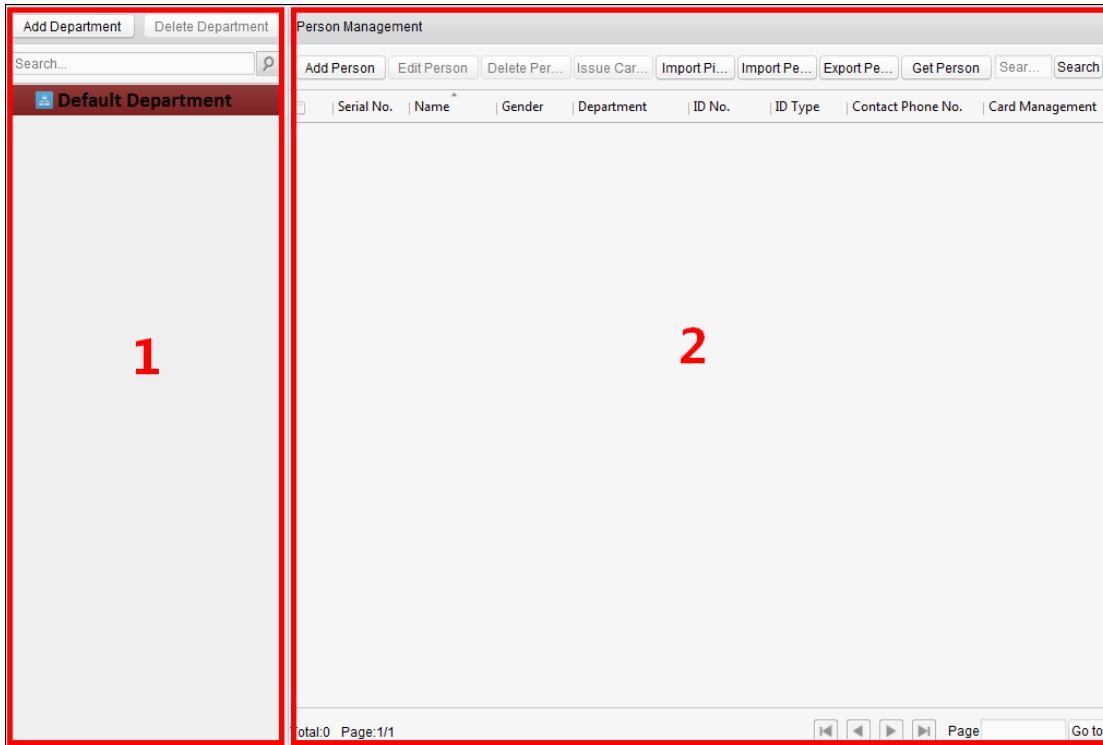

The interface is divided into two parts: Department Management and Person Management.

- **Department Management**
You can add, edit, or delete the department as desired.
- **Person Management**
After adding the department, you can add the person to the department for further management.

Department Management

Adding Department

Steps:

1. In the department list on the left, the Default Department already exists in the client as the parent department of all departments.
2. Select the upper department and click **Add Department** button to pop up the adding department interface to add the lower department.

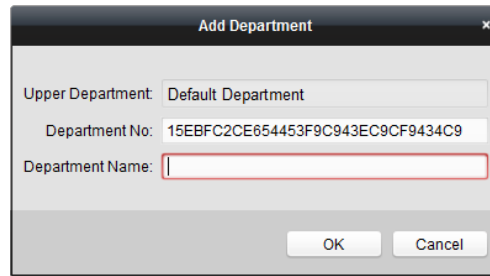

3. Input the Department Name as desired.
4. Click **OK** to save the adding.

Notes:

- You can add multiple levels of departments according to the actual needs. Click a department as the upper-level department and click **Add Department** button, and then the added department will be the sub-department of it.
- Up to 10 levels can be created.

Editing and Deleting Department

You can double-click the added department to edit its name.

You can click to select a department, and click **Delete Department** button to delete it.

Notes:

- The lower-level departments will be deleted as well if you delete a department.
- Make sure there is no person added under the department, or the department cannot be deleted.

Person Management

After adding the department, you can add person to the department and manage the added person such as issuing card in batch, importing and exporting person information in batch, etc..

Note: Up to 2000 persons can be added.

Adding Person (Basic Information)

Steps:

1. Select a department in the department list and click **Add Person** to pop up the adding person interface.
2. Click **Basic Information** tab to input the person’s basic information.

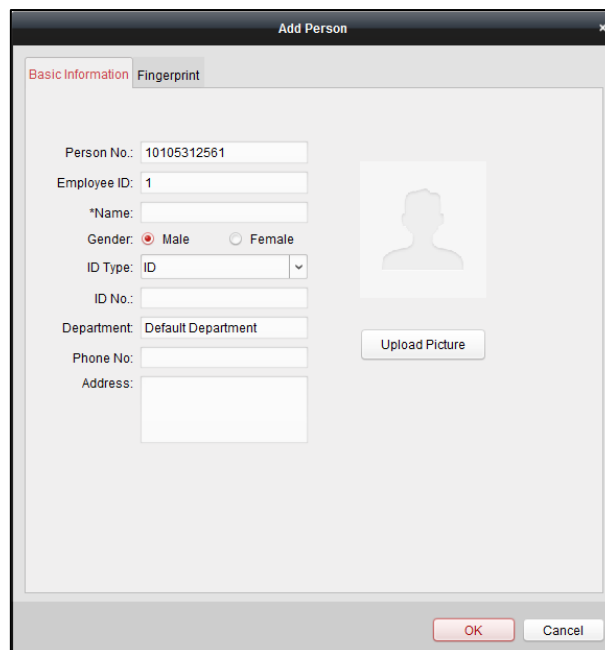

3. The Person No. will be generated automatically and is not editable.

4. Input the basic information including person name, gender, ID type, ID No., contact No., and address.
5. Click **Upload Picture** to select the person picture from the local PC to upload it to the client.
Note: The picture should be in *.jpg, or *.jpeg format.
6. Click **OK** to finish adding.

Adding Person (Fingerprint)

Before inputting the fingerprint, you should connect the fingerprint machine to the PC and set its parameters first. For details, refer to *8.4.3 Fingerprint Machine Configuration*.

Steps:

1. In the Add Person interface, click **Fingerprint** tab.

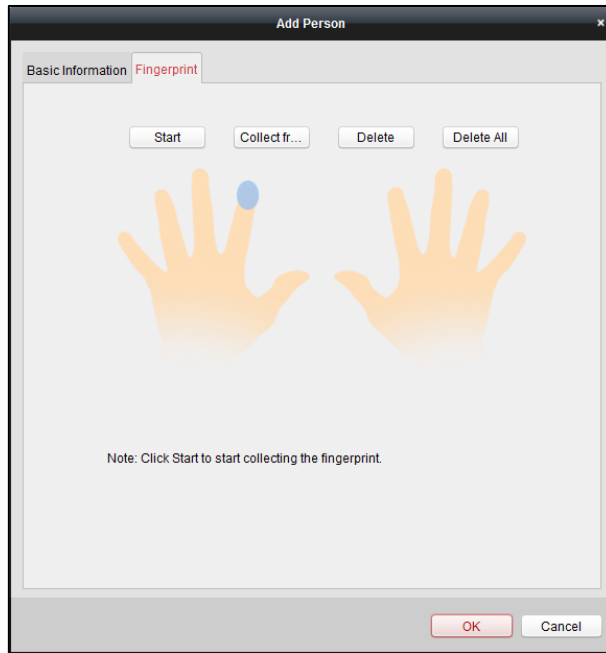

2. Click **Start** button, click to select the fingerprint to start collecting.
3. Lift and rest the corresponding fingerprint on the fingerprint scanner twice to collect the fingerprint to the client.
You can click **Collect from Device** and select the device to scan fingerprint.
You can select the registered fingerprint and click **Delete Fingerprint** to delete it.
You can click **Delete All** to clear all fingerprints.
4. Click **OK** to save the fingerprints.

Editing and Deleting Person

You can double-click the added person to edit its basic information and fingerprint.

Or you can check the checkbox to select the person and click **Edit Person** to edit it.

You can click to select a person, and click **Delete Person** to delete it.

Note: If a card is associated with the current person, the association will be invalid after the person is deleted.

Importing and Exporting Person Information

The person information can be imported and exported in batch.

Steps:

1. After adding the person, you can click **Export Person** button to export all the added person information to the local PC including person No., person name, gender, ID type, ID No., Department, telephone No., and contact address.

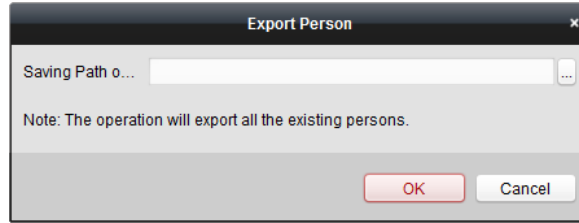

Click  to select the path of saving the exported Excel file.

Click **OK** to start exporting.

- To import the Excel file with person information in batch from the local PC, click **Import Person** button.

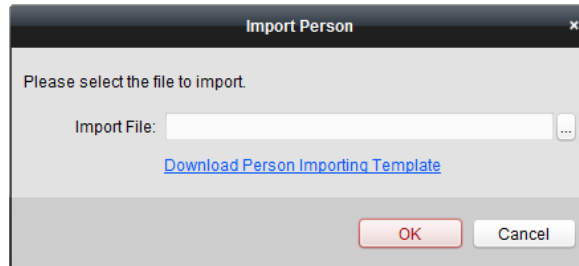

You can click **Download Person Importing Template** to download the template first.

Input the person information to the downloaded template.

Click  to select the Excel file with person information.

Click **OK** to start importing.

Getting Person Information from Access Control Device

If the added access control device has been configured with person information (including person details, fingerprint, issued card information), you can get the person information from the device and import to the client for further operation.

Note: This function is only supported by the device the connection method of which is TCP/IP when adding the device.

Steps:

- In the department list on the left, click to select a department to import the persons to.
- Click **Get Person** button to pop up the following dialog box.

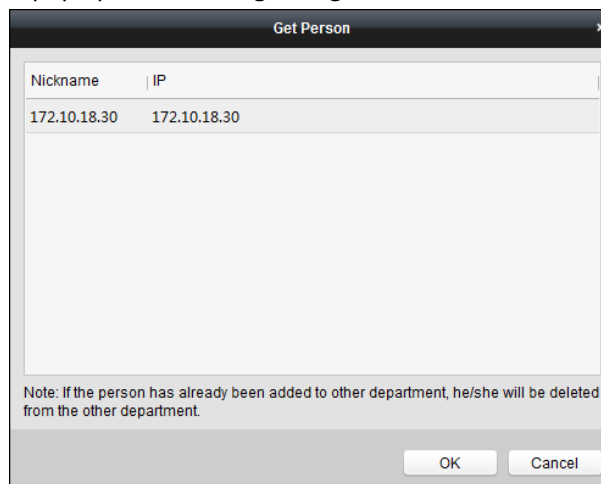

- The added access control device will be displayed.
- Click to select the device and then click **OK** to start getting the person information from the device.
You can also double click the device name to start getting the person information.

Notes:

- The person information, including person details, person’s fingerprint information (if configured), and the linked card (if configured), will be imported to the selected department.
- After getting the person information, if the person has issued card, the card information will be added to the Card Management module of the client as well.
- If the person name stored in the device is empty, the person name will be filled with the issued card No. after importing to the client.
- The gender of the persons will be **Male** by default.

Importing Person Picture

After adding the person information to the client, you can also import person picture to the client in batch.

Before you start:

The person pictures to import should be named after the corresponding person No. As a result, you can export the persons information to get the No. of the persons first.

After naming the pictures after the person No., you can import the pictures in batch.

Steps:

1. Click **Import Picture** button to pop up the Import Picture dialog box..

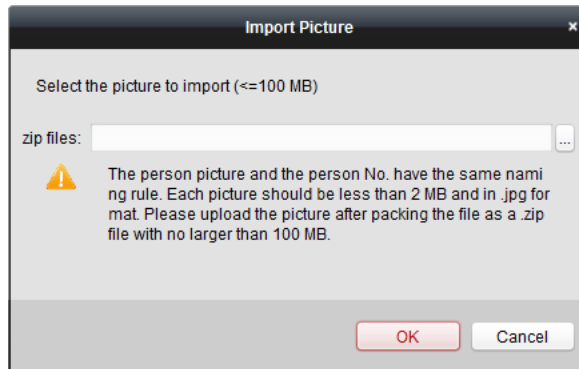

2. Click  to select the package with person pictures and click **OK** to start importing.

Notes:

- The picture name should be the same with the person’s person No..
- Each picture should be less than 2 MB and should be in .jpg format.
- The package file should be .zip file.
- The package file should be less than 100 MB.

Card Operation

After adding the person and card, you can select the person and click  in the Card field for further operation such as issuing card, changing card No., , reporting card loss, card replacement, and returning card.

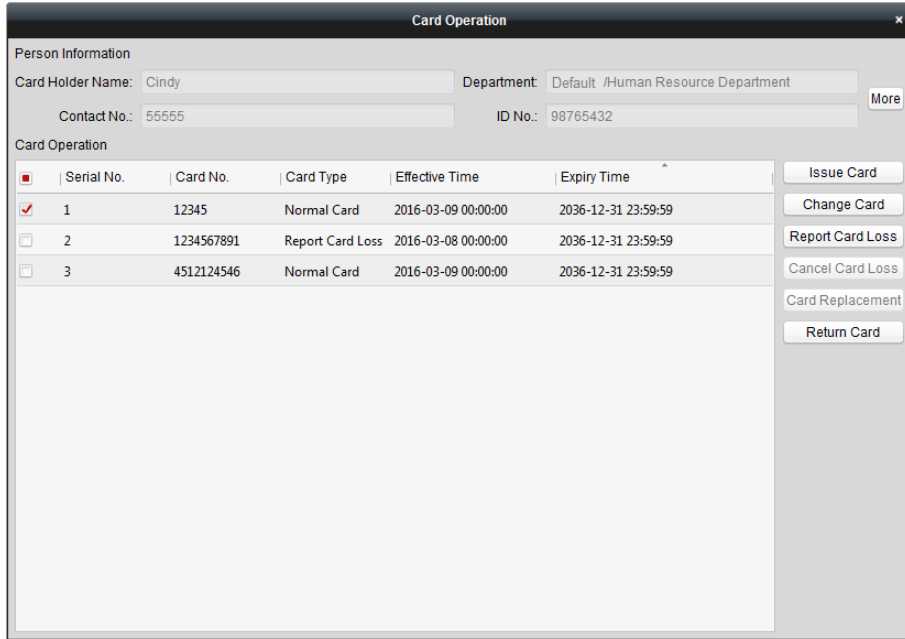

You can click **More** to view the person details.

For details about these operation, please refer to *Chapter 4.2 Card Management*.

Issuing Card in Batch

After adding the card information to the client, you can issuing card for the person in batch. For details about adding the card, please refer to *4.2 Card Management*.

Steps:

1. Check the checkbox to select the person for issuing card.
2. Click **Issur Card in Batch** button to enter the following interface.

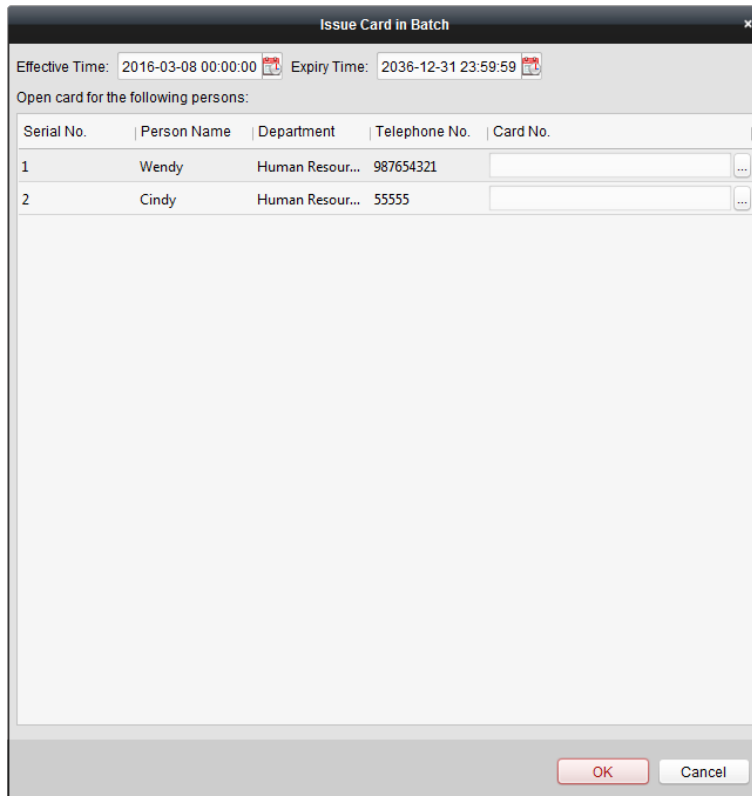

3. Click  to set the effective time and expiry time of the card. Click **OK** to save the time settings.

- 4. In the person list, you can view the selected person details including person name, department, and telephone number.

Click  to select card to be issued to the person.

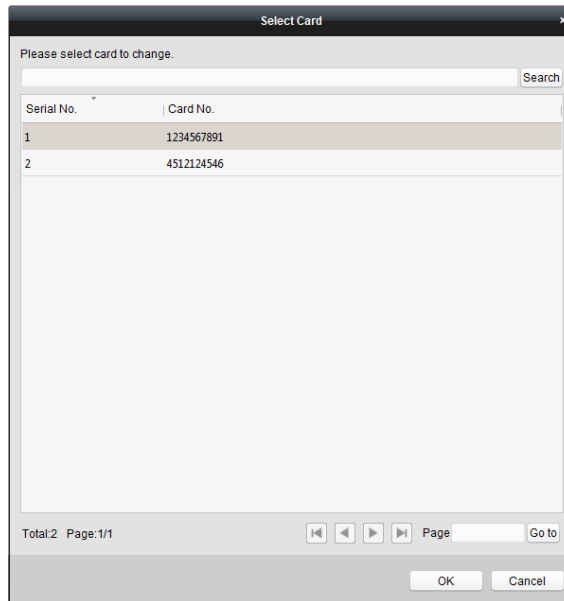

Select the card from the card list and click **OK** to save the settings.

You can input the card No. and click **Search** button to search the card.

- 5. Click **OK** to complete the card issuing.

7.3.2 Card Management



Click [Card Management](#) on the control panel to enter the card management interface.

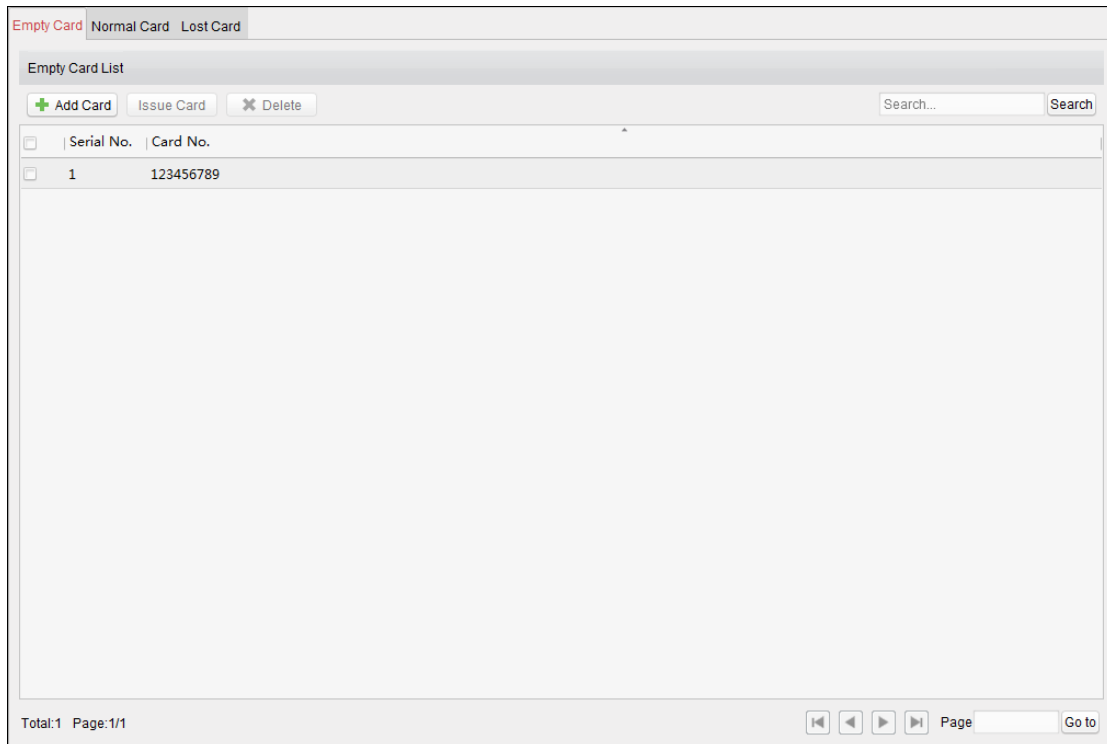

There are three card types: Empty Card, Normal Card, and Lost Card.

Empty Card: A card has not been issued with a person.

Normal Card: A card is issued with a person and is under normal using.

Lost Card: A card is issued with a person and is reported as lost.

Empty Card

Click **Empty Card** tab to manage the empty card first.

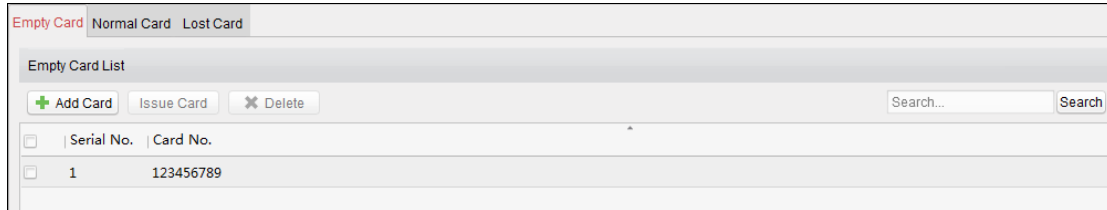

Adding Card

Before you start:

When inputting the card No. when adding the card, you can get the card No. via the following two ways:

- You can get the card No. by the connected card reader. Make sure a card reader is connected to the PC and is configured already. Refer to *8.4.2 Card Reader Configuration* for details.
- You can also get the card No. by scanning the card on the card reader of the access control device. For this situation, please set the mode as **Card Reader Mode** in Editing Access Controller. For details, refer to *3.1.4 Editing Access Control Device*.

The detected card No. will be inputted in the Card No. field automatically.

Perform the following steps to add empty card.

Steps:

1. Click **Add Card** button to pop up the Add Card dialog box.
2. Two adding methods are supported.

✧ Adding Single Card

Select **Single Adding** as the adding mode and input the card No..

Note: Up to 20 characters are allowed in the card No., including digits or letters.

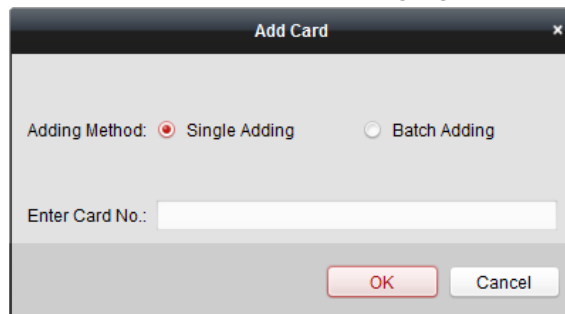

✧ Batch Adding Cards

Select **Batch Adding** as the adding mode. Input the start card No. and the end card No..

Notes:

- The start card No. and the last card No. should be the with same length. E.g., the last card No. is 234, then the start card No. should be like 028.
- For batch adding, the card No. should contain 1 to 10 digits and letters are not allowed.

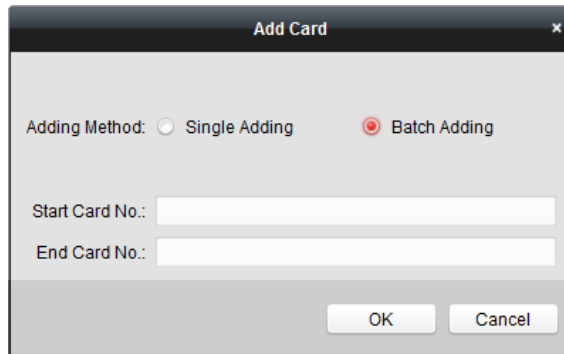

3. Click **OK** button to finish adding.
4. You can check the checkbox of the added card and click **Delete** to delete the card.

Issuing Card

After adding the card to the client, you can issue it to the corresponding added person. You can also issuing the cards to persons in batch. For details, refer to *4.1.2 Person Management*.

Steps:

1. Click an added empty card in the list and click **Issue Card** button to issue the card with a person. You can also double click the empty card in the card list to enter the **Issue Card** interface as follows.

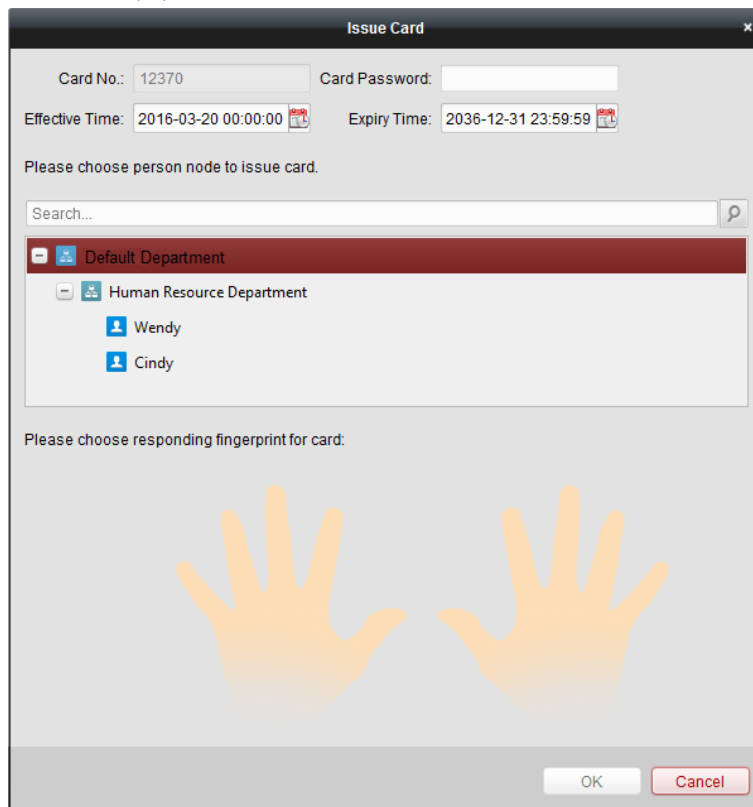

2. Input the password of the card itself. The card password should contain 4 to 8 digits.

Note: The password will be required when the card holder swiping the card to get enter to or exit from the door if you enable the card reader authentication mode as **Card and Password, Password and Fingerprint, and Card, Password, and Fingerprint**. For details, refer to *4.7.2 Card Reader Authentication*.
3. Click  to set the effective time and expiry time of the card. Click **OK** to save the time settings.
4. Click to select a person and select a fingerprint for the card.

Note: To select the person’s fingerprint, you are required to import the fingerprint first. For details, refer to *4.1.2 Person Management*.

5. Click **OK** to finish issuing card.

Notes:

- The issued card will disappear from the Empty Card list, and you can check the card information in the Normal Card list.
- Up to 2000 cards can be added.

Normal Card

After adding the empty card to the client and issue the card to the person, the card will be displayed in the Normal Card list.

Click **Normal Card** tab in the card management interface to show the Normal Card list. You can view all the issued card information, including card No., card holder, and the department of the card holder.

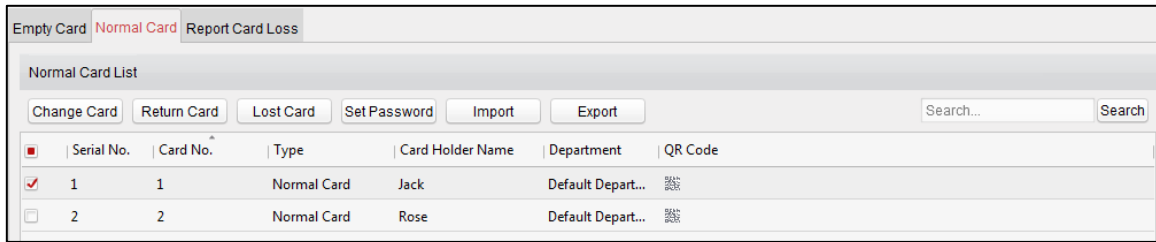

Editing Card

You can double click the normal card in the list to edit the card linked person information.

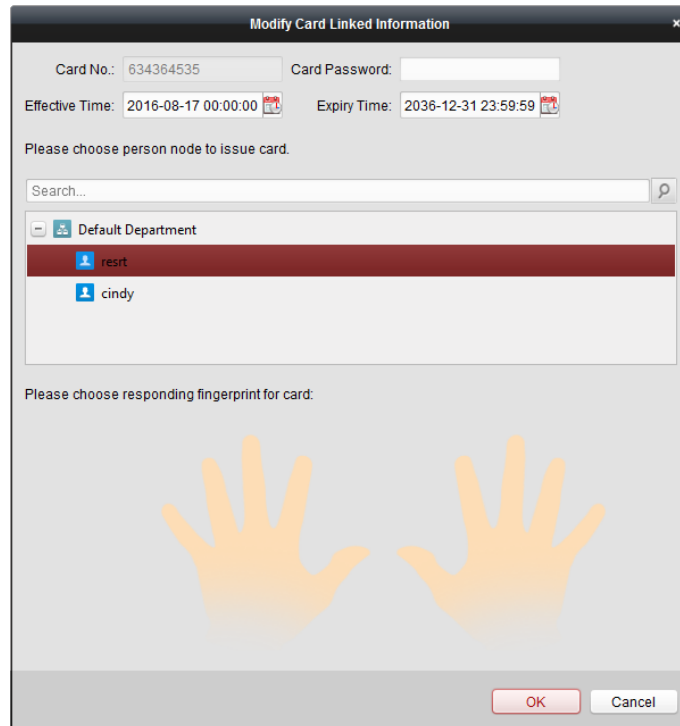

You can edit the card effective time and expiry time, and you can change the person and select the corresponding fingerprint to issue the card again.

Note: To select the person’s fingerprint, you are required to import the fingerprint first. For details, refer to 4.1.2 *Person Management*.

Changing Card

You can change the linked card for the card holder.

Steps:

1. Check the checkbox to select a normal card and click **Change Card** button to change the associated card for card holder.

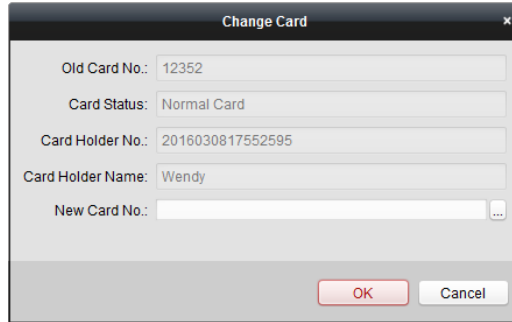

2. In the pop-up window, click  and select another card in the popup window to replace the current card.
3. Click **OK** to save the changes.

Note: After changing the card, the original card will turn to empty card and you can find it in the Empty Card tab page.

Returning Card

You can return the card from normal card to empty status and cancel the linkage between the card and the person.

Steps:

1. Check the checkbox to select an issued card and click **Return Card** button to cancel the association of the card.
2. Click **OK** to confirm the operation.

Then the card will disappear from the Normal Card list, and you can find it in the Empty Card list.

Reporting Card Loss

Steps:

1. Check the checkbox to select an issued card and click **Report Card Loss** button to set the card as the Lost Card, that is, an invalid card.
2. Click **OK** to confirm the operation.

Then the card will disappear from the Normal Card list, and you can find it in the Lost Card list.

Setting Card Password

Steps:

1. Check the checkbox to select an issued card and click **Set Password** button to set the password for the card.

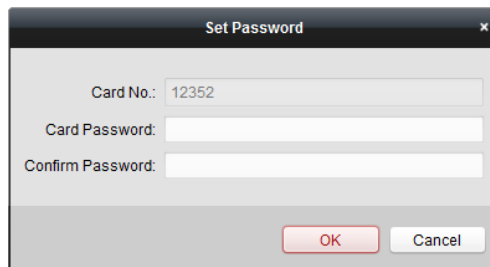

2. Input the card password and confirm the password. The card password should contain 4 to 8 digits.
3. Click **OK** to save the settings.

Note: The password will be required when the card holder swiping the card to get enter to or exit from the door if you enable the card reader authentication mode of **Card and Password**, **Password and Fingerprint**, and **Card, Password, and Fingerprint**. For details, refer to 4.7.2 Card Reader Authentication.

Importing and Exporting Cards

Steps:

1. To import the card and person information from the local PC, click **Import** button to pop up the following dialog box.

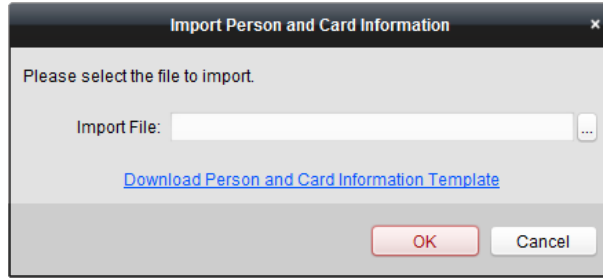

Click **Download Person and Card Infotmation Template** to download the template for importing.

In the template file, input the card holder name and the corresponding card No..

Note: The Card No. should be 1 to 20 digits

Click  to select the template file with card and person information.

Click **OK** to start importing.

2. To export all the normal card information to the local PC, click **Export** button to pop up the following dialog box.

Click  to select the path to save the exported file.

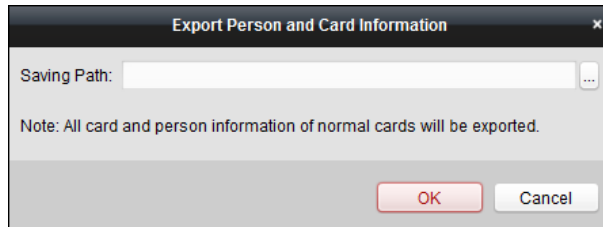

Click **OK** to start exporting. All the normal cards with card holder name and card No. will be exported to the Excel file.

Saving QR Code Picture

Steps:

1. Click the QR code button in the Normal Card list.

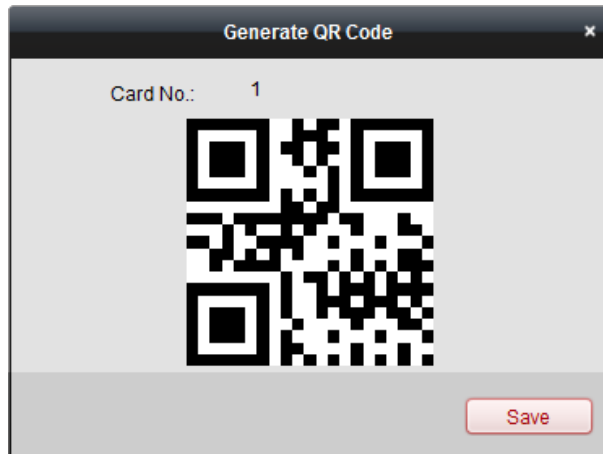

2. Click **Save** in the pop-up QR code window.
3. Select the saving path in the pop-up window.
4. Click **OK** to save the picutre.

Lost Card

You can manage the card which is reported as lost, including canceling card loss and replacing card.

Click **Lost Card** tab in the card managemet interface to show the Lost Card list. You can view all the lost card information, including card No., card holder, and the department of the card holder.

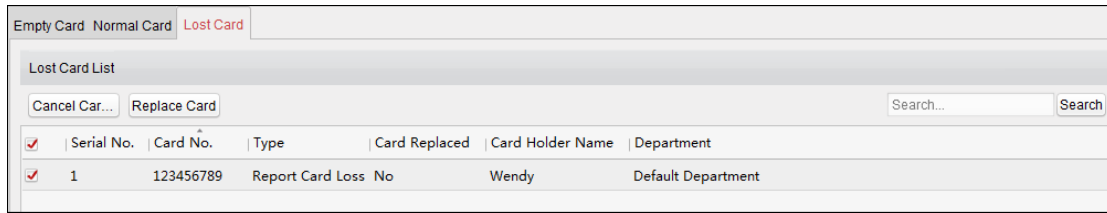

Canceling Card Loss

If the lost card is found, you can cancel the loss for the card and the lost card will turn to normal card.

Steps:

1. Check the checkbox to select the lost card in the list.
2. Click **Cancel Card Loss** button to resume the card to the normal card.
3. Click **OK** to confirm the operation.

Card Replacement

If the lost card cannot be found any more, you can replace the lost card with a new card.

Steps:

1. Check the checkbox to select the lost card in the list.
2. Click **Replace Card** button to issue a new card to the card holder replacing for the lost card.

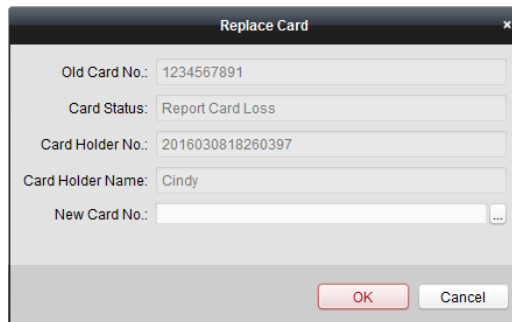

3. Click **[...]** button to select another card in the popup window as the new card and the predefined permissions of the lost card will be copied to the new one automatically.
4. Click **OK** to save the changes.

7.3.3 Schedule Template

Purpose:

You can configure the schedule template including week schedule and holiday schedule. After setting the templates, you can adopt the configured templates to access control permissions when setting the permission, so that the access control permission will take effect in the time durations of the schedule template.



Click **Template** on the control panel to enter the schedule template interface.

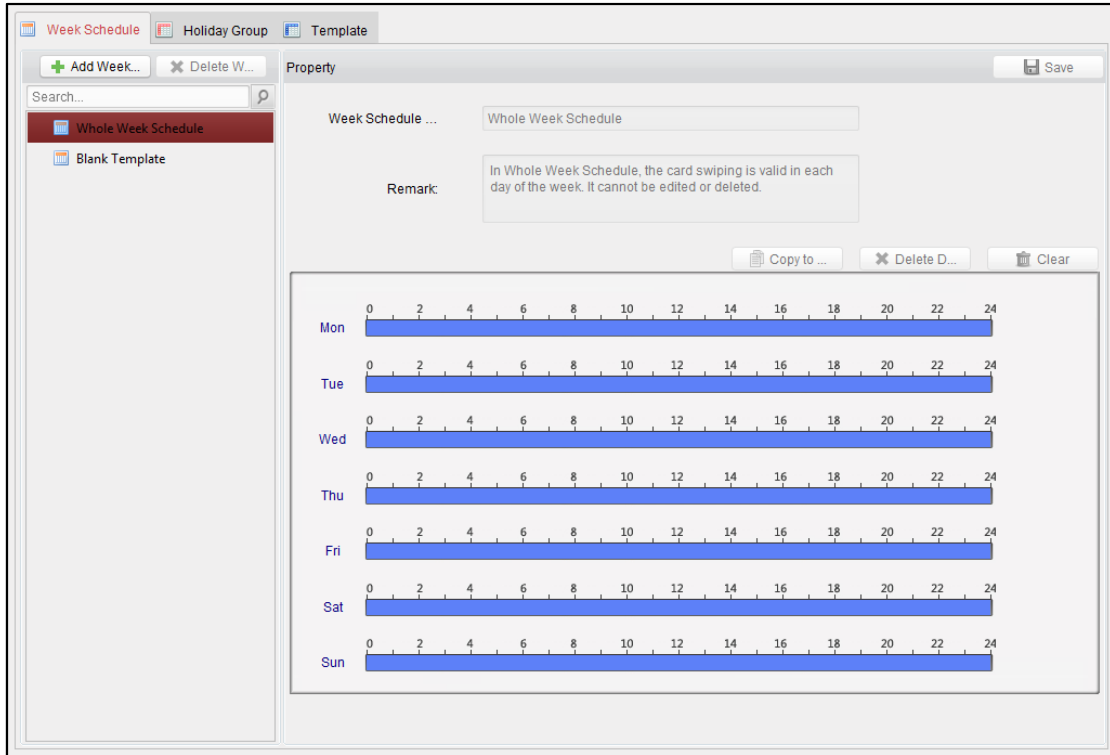

You can manage the schedule of access control permission including Week Schedule, Holiday Schedule, and Template. For permission settings, please refer to 4.6 *Permission Configuration*.

Week Schedule

Click **Week Schedule** tab to enter the Week Schedule Management interface.

The client defines two kinds of week plan by default: **Whole Week Schedule** and **Blank Schedule**, which cannot be deleted and edited.

- **Whole Week Schedule:** Card swiping is valid on each day of the week.
- **Blank Schedule:** Card swiping is invalid on each day of the week.

You can define custom schedules on your demand.

Steps:

1. Click  button to pop up the adding schedule interface.

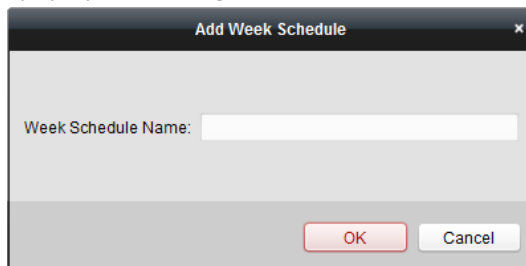

2. Input the name of week schedule and click **OK** button to add the week schedule.
3. Select the added week schedule in the schedule list on the left and you can view its property on the right.
4. You can edit the week schedule name and input the remark information.
5. On the week schedule, click and drag on a day to draw on the schedule, which means in that period of time, the configured permission is activated.

Note: Up to 8 time periods can be set for each day in the schedule.

6. When the cursor turns to , you can move the selected time bar you just edited. You can also edit the displayed time point to set the accurate time period.

When the cursor turns to , you can lengthen or shorten the selected time bar.

7. Optionally, you can select the schedule time bar, and then click **Delete Duration** to delete the selected time bar, or click **Clear** to delete all the time bars, or click **Copy to Week** to copy the time bar settings to the whole week.
8. Click **Save** to save the settings.

Holiday Group

Click **Holiday Group** tab to enter the Holiday Group Management interface.

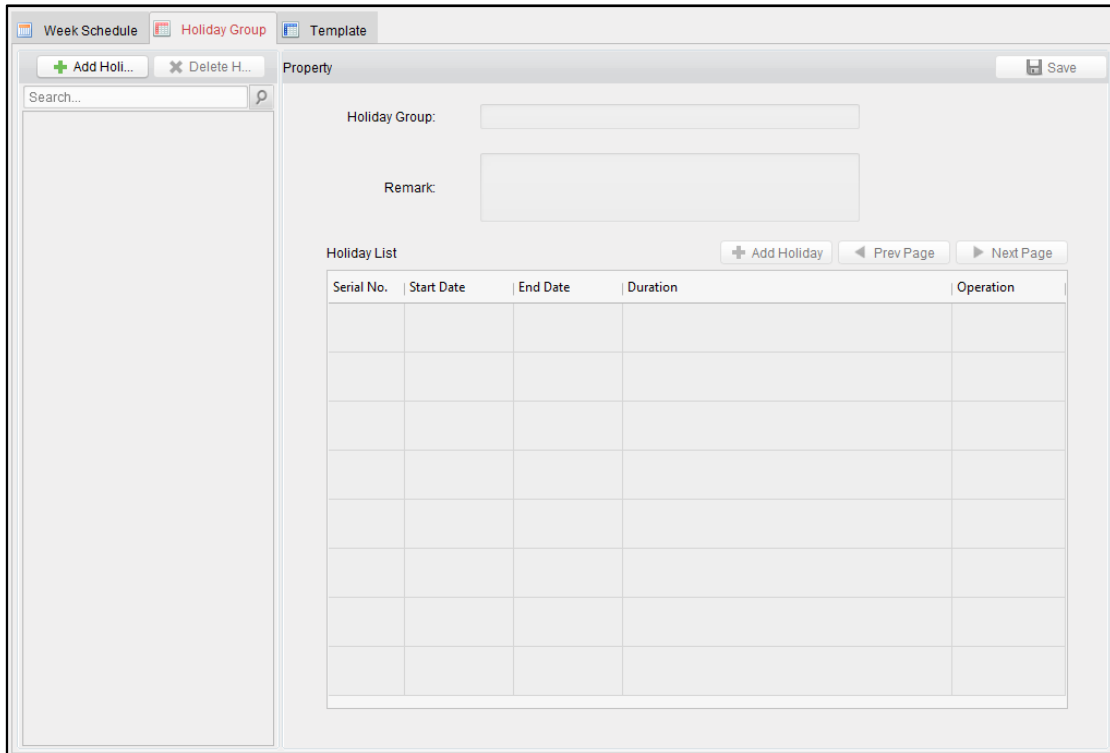

Steps:

1. Click **Add Holiday Group** button on the left to pop up the adding holiday group interface.

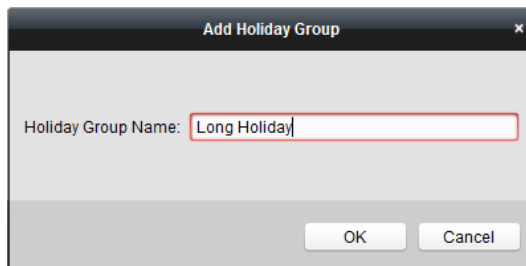



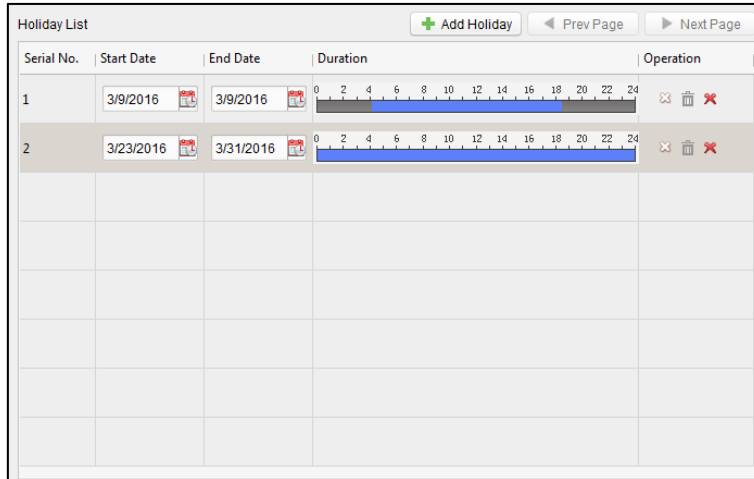

2. Input the name of holiday group in the text filed and click **OK** button to add the holiday group.
3. Select the added holiday group and you can edit the holiday group name and input the remark information.
4. Click **Add Holiday** icon on the right to add a holiday period to the holiday list and configure the duration of the holiday.

Note: Up to 16 holidays can be added to one holiday group.



- 1) On the period schedule, click and drag to draw the period, which means in that period of time, the configured permission is activated.

Note: Up to 8 time durations can be set for each period in the schedule.

- 2) When the cursor turns to , you can move the selected time bar you just edited. You can also edit the displayed time point to set the accurate time period.
- 3) When the cursor turns to , you can lengthen or shorten the selected time bar.
- 4) Optionally, you can select the schedule time bar, and then click  to delete the selected time bar, or click  to delete all the time bars of the holiday, or click  to delete the holiday directly.

5. Click **Save** to save the settings.

Note: The holidays cannot be overlapped with each other.

Schedule Template

After setting the week schedule and holiday group, you can configure the schedule template which contains week schedule and holiday group schedule.

Note: The priority of holiday group schedule is higher than the week schedule.

Click **Schedule Template** tab to enter the Schedule Template Management interface.

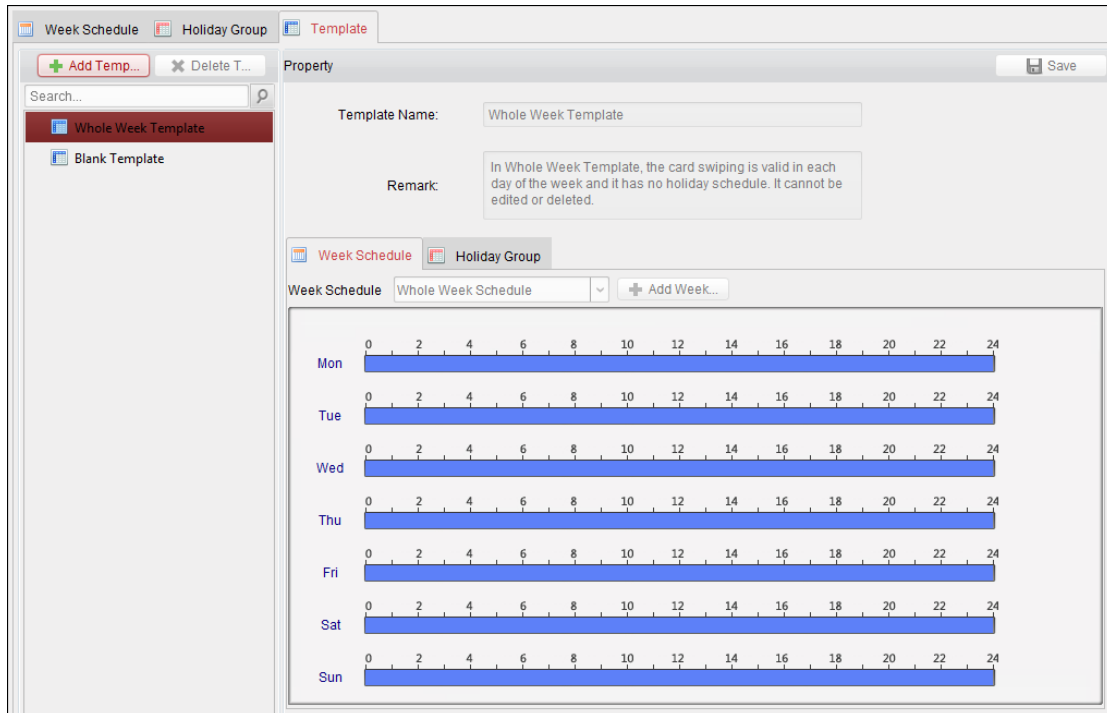

There are two pre-defined templates by default: **Whole Week Template** and **Blank Template**, which cannot be deleted and edited.

- **Whole Week Template:** The card swiping is valid on each day of the week and it has no holiday group schedule.
 - **Blank Template:** The card swiping is invalid on each day of the week and it has no holiday group schedule.
- You can define custom templates on your demand.

Steps:

1. Click **Add Template** to pop up the adding template interface.

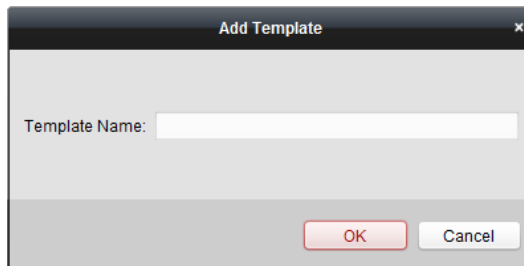

2. Input the template name in the text field and click **OK** button to add the template.
3. Select the added template and you can edit its property on the right. You can edit the template name and input the remark information.
4. Select a week schedule to apply to the schedule.
Click **Week Schedule** tab and select a schedule in the dropdown list.
You can also click **Add Week Schedule** to add a new week schedule. For details, refer to 4.3.1 *Week Schedule*.

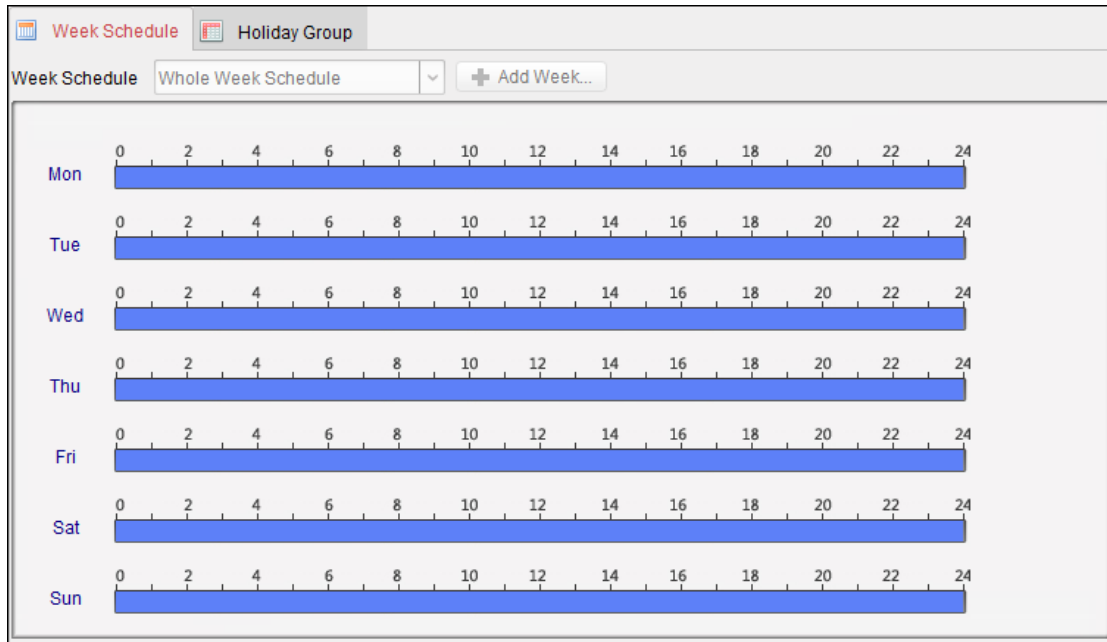

5. Select holiday groups to apply to the schedule.

Note: Up to 4 holiday groups can be added.

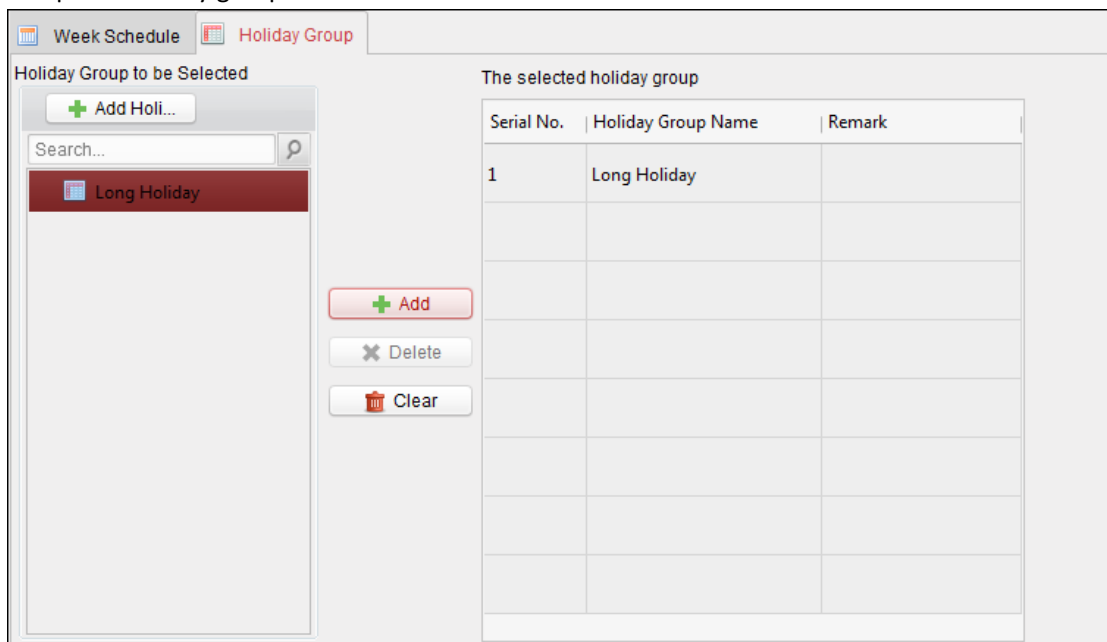

Click to select a holiday group in the list and click **Add** to add it to the template. You can also click **Add Holiday Group** to add a new one. For details, refer to 4.3.2 *Holiday Group*.

You can click to select an added holiday group in the right-side list and click **Delete** to delete it.

You can click **Clear** to delete all the added holiday groups.

6. Click **Save** button to save the settings.

7.3.4 Door Status Management

Purpose:

You can anti-control the door via the client and set the door status duration.



Click **Status Monitor** icon on the control panel to enter the Status Monitor interface.

Anti-control the Access Control Point (Door)

Purpose:

You can control the status for a single access control point (a door).

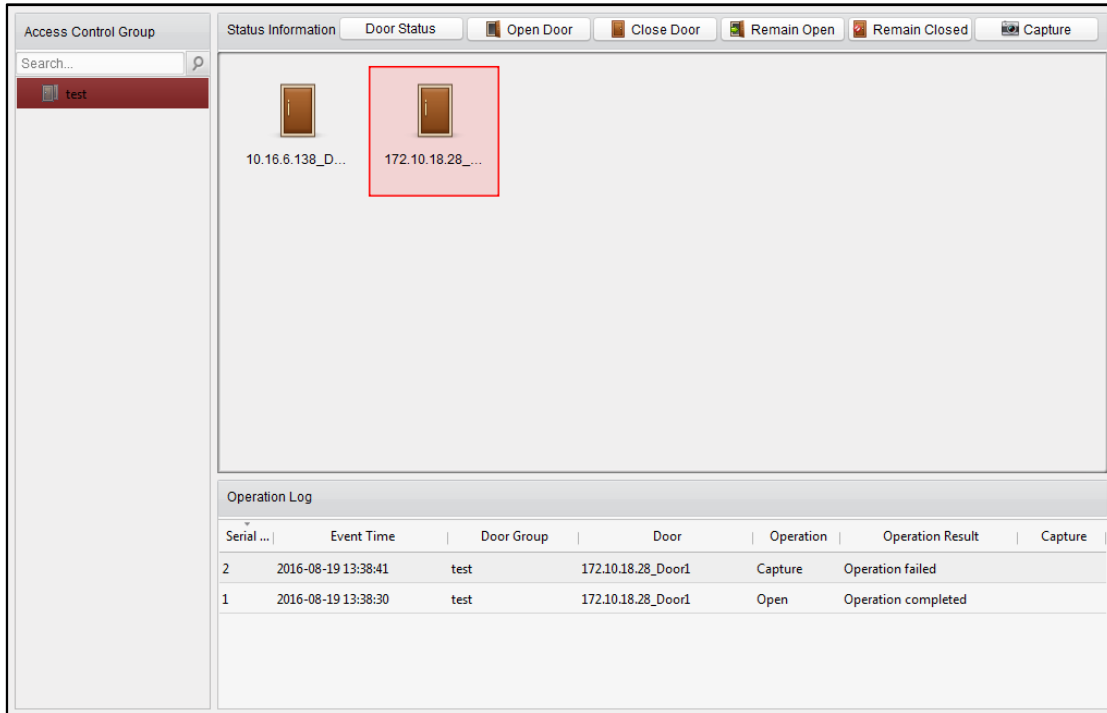





Steps:

1. Select an access control group on the left. For managing the access control group, refer to 3.6.1 Access Control Group Management.
2. The access control points of the selected access control group will be displayed on the right.



Click icon  on the Status Information panel to select a door.

3. Click the following button listed on the **Status Information** panel to control the door.

-  **Open Door** : Click to open the door once.
-  **Close Door** : Click to close the door once.
-  **Remain Open** : Click to keep the door open.
-  **Remain Closed** : Click to keep the door closed.
-  **Capture** : Click to capture the picture manually.

4. You can view the anti-control operation result in the Operation Log panel.

Notes:

- If you select the status as **Remain Open/Remain Closed**, the door will keep open/closed until a new anti-control command being made.
- The **Capture** button is available when the device supports capture function. And it cannot be realized until the storage server is configured. Refer to 8.4.4 Storage Server Configuration.

Status Duration Configuration

Purpose:

You can schedule weekly time periods for an access control point (door) to remain open or closed.



Click **Status Monitor** icon on the control panel and click **Status Duration** button to enter the Status Duration interface.

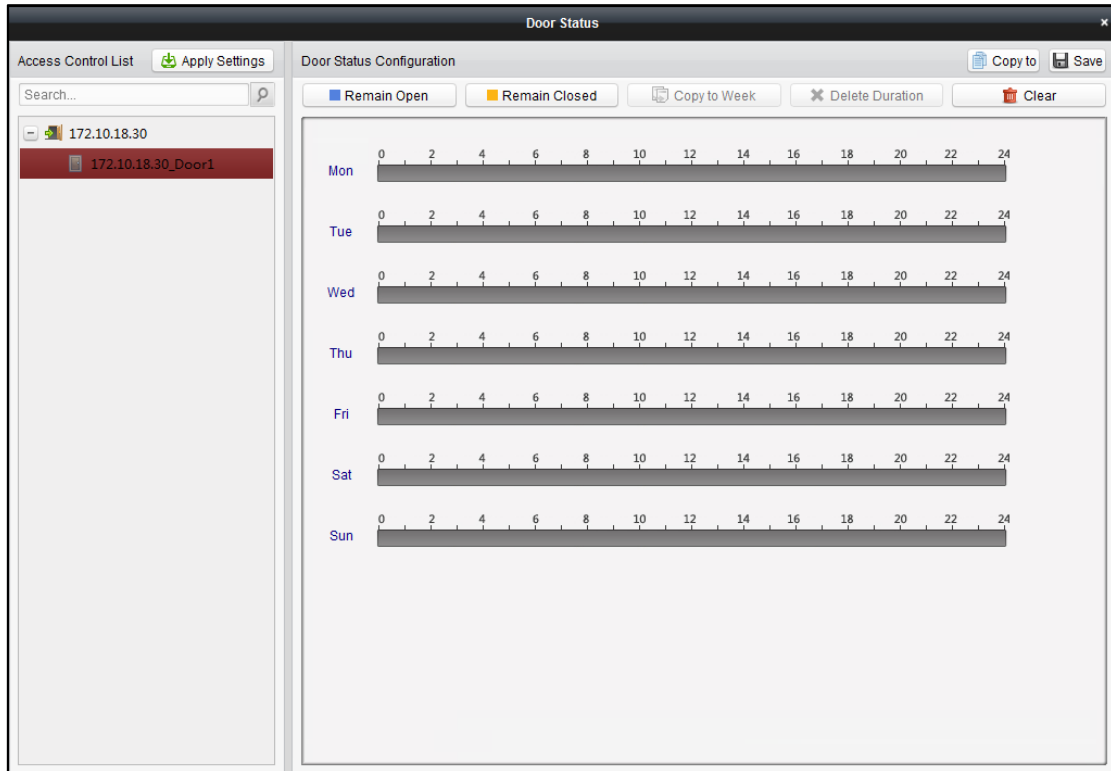



Steps:

1. Click to select a door from the access control list on the left.
2. On the Door Status Configuration panel on the right, draw a schedule for the selected door.
 - 1) Select a door status brush as or .
 - Remain open:** The door will keep open during the configured time period. The brush is marked as ■.
 - Remain Closed:** The door will keep closed during the configured duration. The brush is marked as ■.
 - 2) Click and drag on the timeline to draw a color bar on the schedule to set the duration.



Note: The min. segment of the schedule is 30min.

When the cursor turns to , you can move the selected time bar you just edited. You can also edit the displayed time point to set the accurate time period.

When the cursor turns to , you can lengthen or shorten the selected time bar.

3. Optionally, you can select the schedule time bar and click **Copy to Other Day** to copy the time bar settings to the other dates
4. You can select the time bar and click Delete Duration to delete the time period.
Or you can click **Clear** to clear all configured durations on the schedule.
5. Click **Save** to save the settings.
6. You can click **Copy to** button to copy the schedule to other doors.
7. Click **Apply Settings** to pop up the Apply Status Duration Setting dialog box.

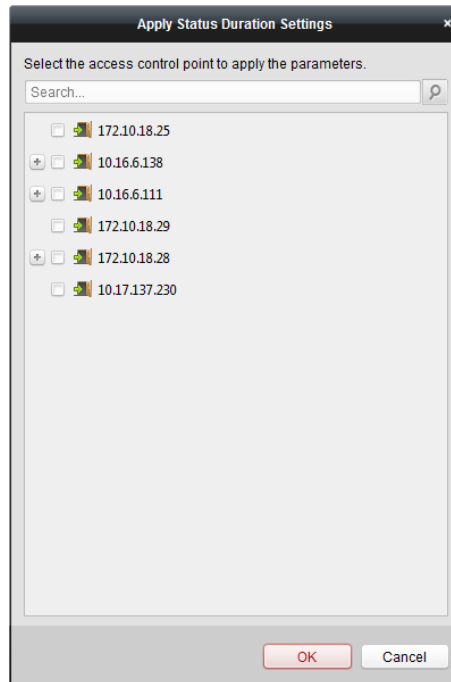

Select a control point and click **OK** to apply the settings to access control point.

Note: The door status duration settings will take effect after applying the settings to the access control point.

7.3.5 Linkage Configuration



Click [Linkage Configuration](#) on the control panel to enter the Linkage Configuration interface.

You can set alarm linkage modes of the access control device, including event alarm linkage, event card linkage, and client linkage.

Event/Card/MAC Linkage

In the Linkage Configuration interface, click **Event Card Linkage** tab to enter the following interface.

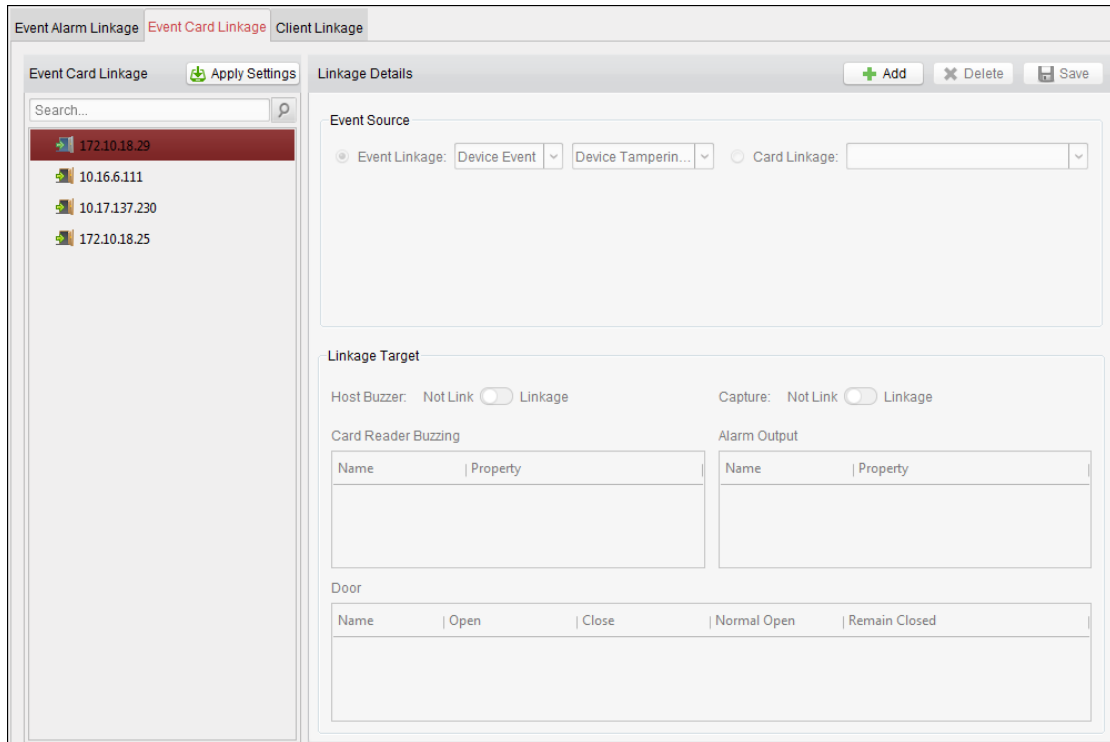

Select the access control device from the list on the left.

Click **Add** button to add a new linkage. You can select the event source as **Event Linkage** or **Card Linkage**.

Event Linkage

For the event linkage, the alarm event can be divided into four types: device event, alarm input, door event, and card reader event.

Steps:

1. Click to select the linkage type as **Event Linkage**, and select the event type from the dropdown list.
 - For Device Event, select the detailed event type from the dropdown list.
 - For Alarm Input, select the type as alarm or alarm recovery and select the alarm input name from the table.
 - For Door Event, select the detailed event type and select the door from the table.
 - For Card Reader Event, select the detailed event type and select the card reader from the table.
2. Set the linkage target, and switch the property from to to enable this function.
 - **Host Buzzer**: The audible warning of controller will be triggered.
 - **Capture**: The real-time capture will be triggered.
 - **Reader Buzzer**: The audible warning of card reader will be triggered.
 - **Alarm Output**: The alarm output will be triggered for notification.
 - **Door**: The door status of open, close, remain open, and remain close will be triggered.

Note: The door status of open, close, remain open, and remain close cannot be triggered at the same time.

3. Click **Save** button to save parameters.
4. Click **Apply Settings** to apply the updated parameters to the local memory of the device to take effect.

Card Linkage

Steps:

1. Click to select the linkage type as **Card Linkage**.
2. Input the card No. or select the card from the dropdown list.
3. Select the card reader from the table for triggering.
4. Set the linkage target, and switch the property from to to enable this function.
 - **Host Buzzer**: The audible warning of controller will be triggered.

Capture: The real-time capture will be triggered.

Reader Buzzer: The audible warning of card reader will be triggered.

Alarm Output: The alarm output will be triggered for notification.

5. Click **Save** button to save parameters.
6. Click **Apply Settings** to apply the updated parameters to the local memory of the device to take effect.

MAC Linkage

You can link the device by setting the MAC address.

1. Select a device in the event card linkage list.
2. Click **Add** in the Linkage Details page.
3. Select **MAC Linkage** in the Event Source part. And input the MAC address in the text box.

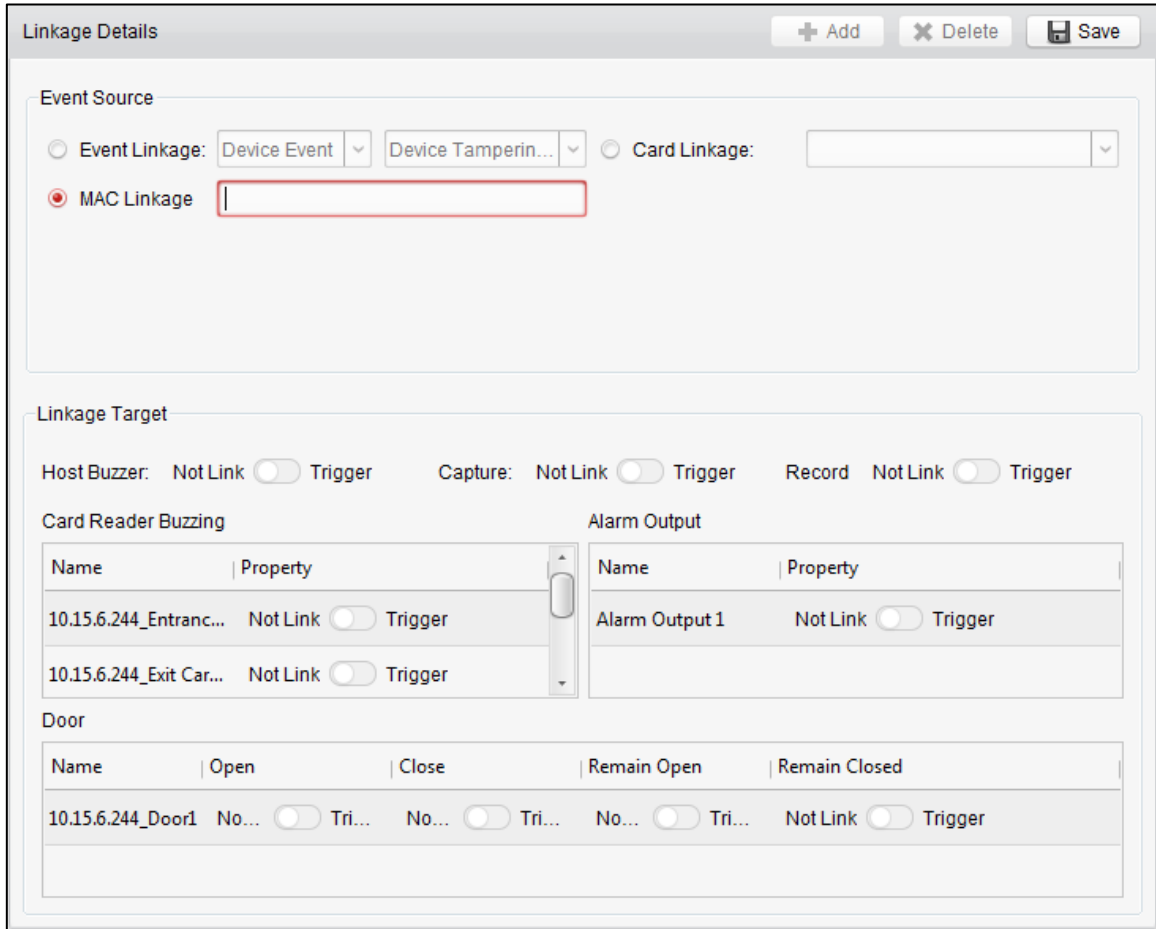



4. Set the linkage target parameters, including the host buzzer the capture, the record, the card reader buzzing, the alarm out, and the door.
5. Click **Save** to save the settings.
6. Click **Apply Settings** to apply the updated parameters to the local memory of the device to take effect.

Client Linkage

Purpose:

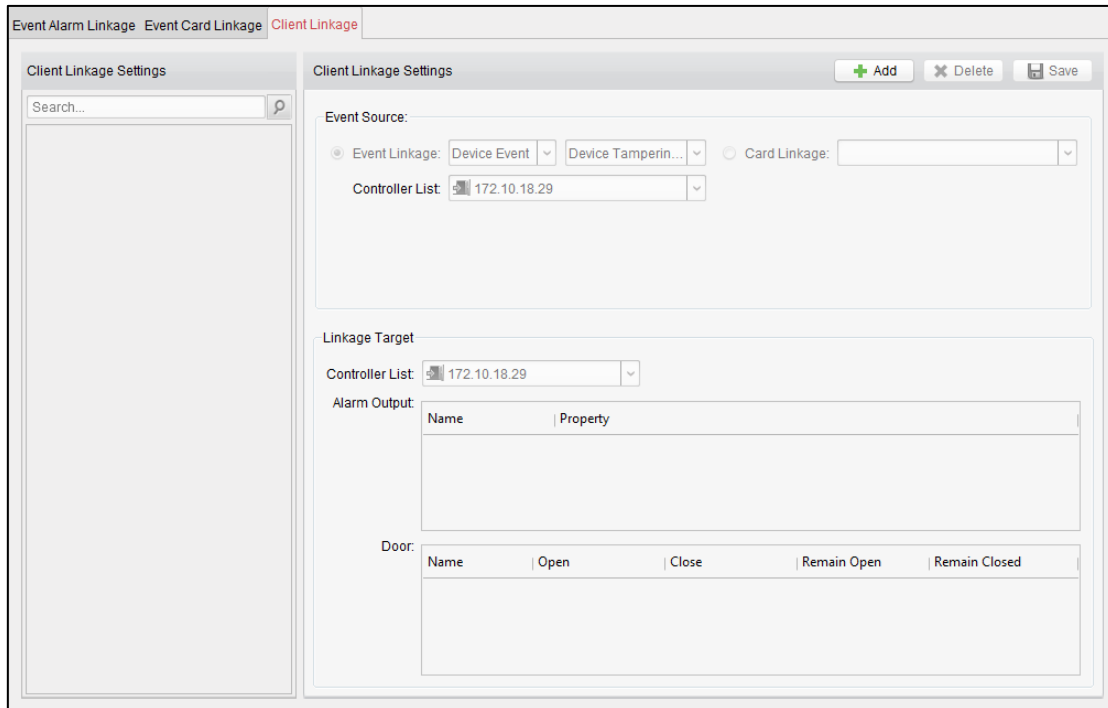
You can assign other access control device linkage actions to the trigger by setting up a rule in client linkage. In the Linkage Configuration interface, click **Client Linkage** tab to enter the following interface.





Click  **Add** button to add a new client linkage. You can select the event source as **Event Linkage** or **Card Linkage**.

Event Linkage



For the event linkage, the alarm event can be divided into four types: device event, alarm input, door event, and card reader event.

Steps:

1. Click to select the linkage type as **Event Linkage**, select the access control device as event source, and select the event type from the dropdown list.
 - For Device Event, select the detailed event type from the dropdown list.
 - For Alarm Input, select the type as alarm or alarm recovery and select the alarm input name from the table.
 - For Door Event, select the detailed event type and select the door from the table.
 - For Card Reader Event, select the detailed event type and select the card reader from the table.
2. Set the linkage target, select the access control device from the dropdown list as the linkage target, and switch the property from  to  to enable this function.
 - **Alarm Output:** The alarm output will be triggered for notification.
 - **Door:** The door status of open, close, remain open, and remain close will be triggered. **Note:** The door status of open, close, remain open, and remain close cannot be triggered at the same time.
3. Click **Save** button to save parameters.

Card Linkage

Steps:

1. Click to select the linkage type as **Card Linkage**.
2. Select the card from the dropdown list and select the access control device as event source.
3. Select the card reader from the table for triggering.
4. Set the linkage target, select the access control device from the dropdown list as the linkage target, and switch the property from  to  to enable this function.
 - **Alarm Output:** The alarm output will be triggered for notification.
5. Click **Save** button to save parameters.

7.3.6 Permission Configuration



Click [Access Control Permission](#) icon on the control panel to enter the Access Control Permission interface.

In Permission Configuration module, you can add, edit, and delete the access control permission, and then apply the permission settings to the device to take effect.

<input type="checkbox"/>	Serial No.	Person Name	Department	Access Control	Door Group	Template	Status
<input type="checkbox"/>	1	Cindy		10.16.6.111_Door1	test	Whole Week Template	Not Applied
<input type="checkbox"/>	2	Cindy		172.10.18.25_Door1		Whole Week Template	Applied
<input type="checkbox"/>	3	Cindy		172.10.18.25_Door2		Whole Week Template	Applied
<input type="checkbox"/>	4	Cindy		172.10.18.25_Door3		Whole Week Template	Applied
<input type="checkbox"/>	5	Cindy		172.10.18.25_Door4		Whole Week Template	Applied
<input type="checkbox"/>	6	Jess		10.16.6.111_Door1	test	Whole Week Template	Not Applied
<input type="checkbox"/>	7	Jess		172.10.18.25_Door1		Whole Week Template	Applied
<input type="checkbox"/>	8	Jess		172.10.18.25_Door2		Whole Week Template	Applied
<input type="checkbox"/>	9	Jess		172.10.18.25_Door3		Whole Week Template	Applied
<input type="checkbox"/>	10	Jess		172.10.18.25_Door4		Whole Week Template	Applied
<input type="checkbox"/>	11	John		10.17.137.230_Door1	test	Whole Week Template	Not Applied
<input type="checkbox"/>	12	John		10.16.6.111_Door1	test	Whole Week Template	Not Applied
<input type="checkbox"/>	13	John		172.10.18.25_Door1		Whole Week Template	Applied
<input type="checkbox"/>	14	John		172.10.18.25_Door2		Whole Week Template	Applied
<input type="checkbox"/>	15	John		172.10.18.25_Door3		Whole Week Template	Applied
<input type="checkbox"/>	16	John		172.10.18.25_Door4		Whole Week Template	Applied
<input type="checkbox"/>	17	Marry		10.16.6.111_Door1	test	Whole Week Template	Not Applied
<input type="checkbox"/>	18	Marry		172.10.18.25_Door1		Whole Week Template	Applied
<input type="checkbox"/>	19	Marry		172.10.18.25_Door2		Whole Week Template	Applied
<input type="checkbox"/>	20	Marry		172.10.18.25_Door3		Whole Week Template	Applied
<input type="checkbox"/>	21	Marry		172.10.18.25_Door4		Whole Week Template	Applied

Adding Permission

Purpose:

You can assign permission for people/department to enter/exist the control points (doors) in this section.

Steps:

1. Click **Add** icon on the upper-left side of the page to enter following interface.

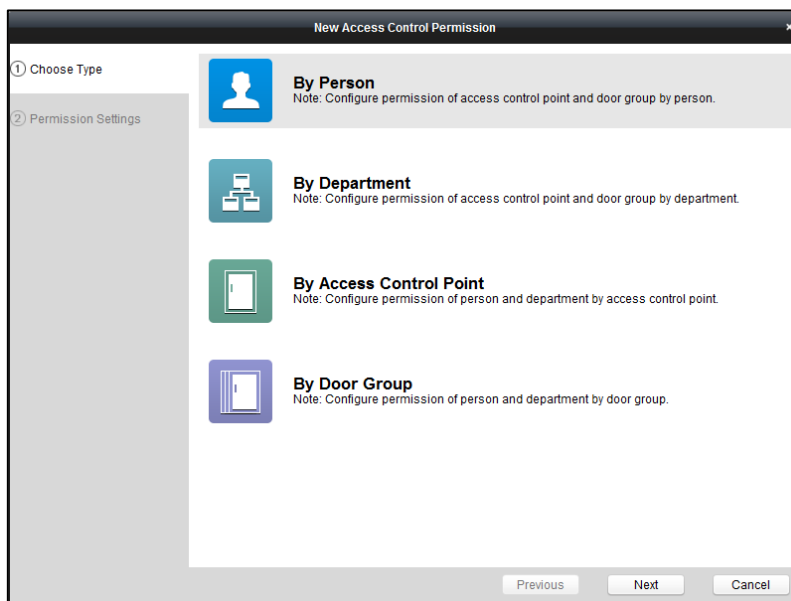

2. Select the permission type.

- **By Person:** You can select people from the list to enter/exit the door.
- **By Department:** You can select departments from the list to enter/exit the door. Once the permission is allocated, all the people in this department will have the permission to access the door.
- **By Access Control Point:** You can select doors from the door list for people to enter/exit.
- **By Door Group:** You can select groups from the door list for people to enter/exit. The permission will take effect on the door in this group.

Note: The Door Group Permission will be available after the door group is added. For details about the door group, refer to *3.2 Door Group Management*.

3. Click **Next** to enter the **Permission Settings** interface.

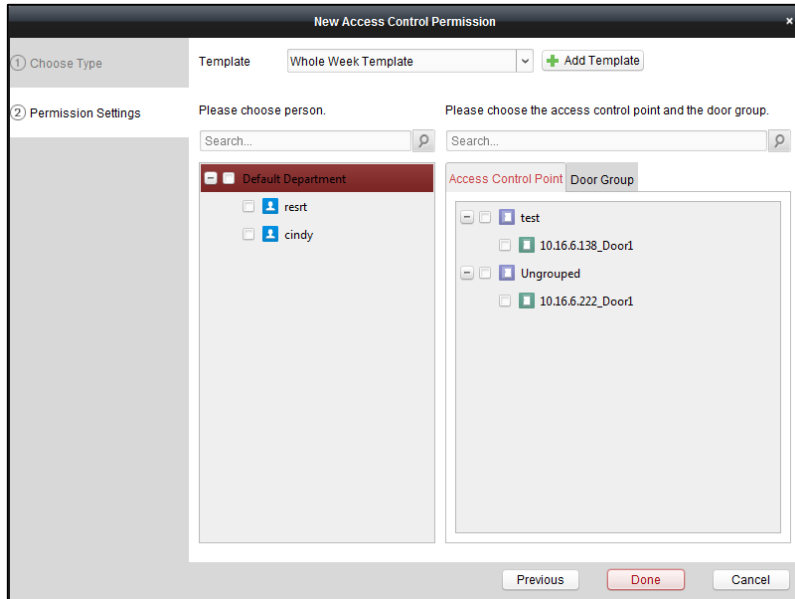

4. Click on the dropdown menu to select a schedule template for the permission.

Note: The schedule template must be configured before any permission settings. You can click **Add Template** button to add the schedule template. Refer to *4.3 Schedule Template* for details.

5. Select people/department and corresponding doors/door groups from the appropriate lists.

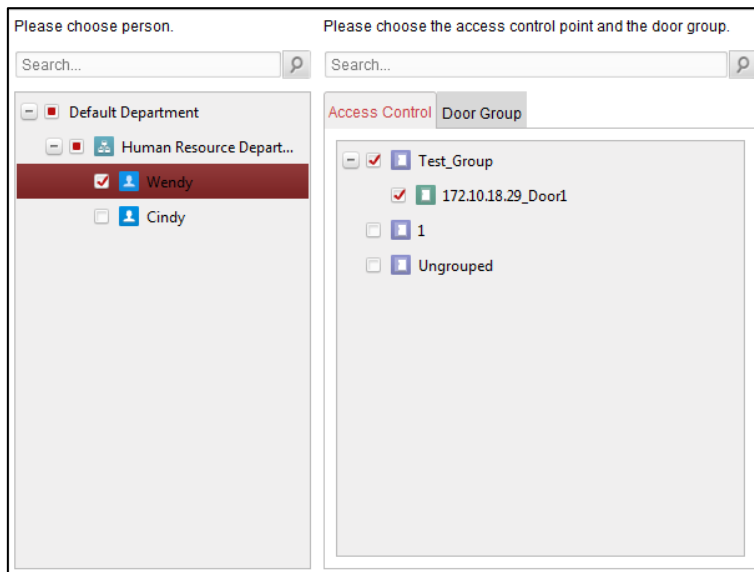

6. Click **Finish** button to complete the permission adding.

7. (Optional) You can double click **Template** column of the added permission in the list to edit its permission

schedule template.

You can select the added permission in the list and click **Delete** to delete it.

Applying Permission

You can apply the added permission to the access control to take effect.

Steps:

1. Click **Apply** to enter the Apply Permission interface as follows.

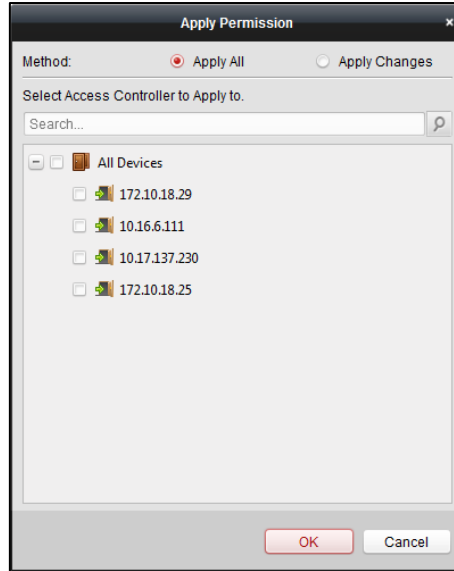

2. Select the Applying Method.
 - **Apply All:** Apply all the permission settings in the list to the selected access control device.
 - **Apply Changes:** Apply the changed permissions to the selected access control device.
3. Select an access control device and click **OK** button to start applying the permission to the device.

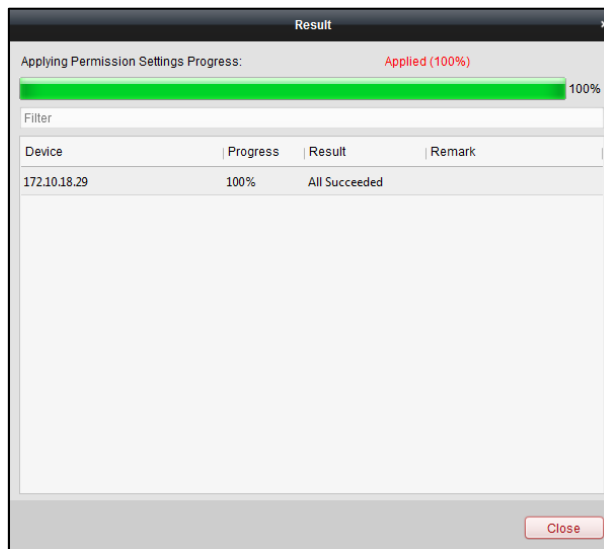



Importing/Exporting Permission

You can also export the added permissions information to the local PC and import the permissions in batch from the local PC.

Steps:

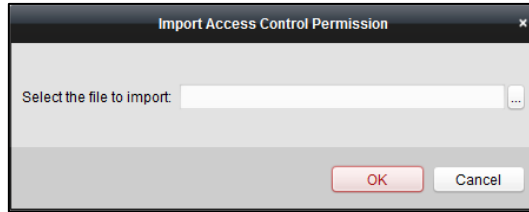
1. To import the permission in batch, click **Import** button to pop up the following dialog box.



Click  to select the package file containing the permission information.
Click **OK** to start importing.

- To export the permissions to the local PC, click **Export** button to pop up the following dialog box.

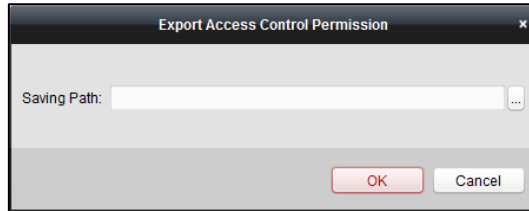

Click , input the permission file name as desired and select the saving path of the exported package file containing the permission information.

Click **OK** to start exporting.

Note: The exported permission file is not editable.

Searching Access Control Permission

You can search the added access control permission via the client.

Steps:

- Click **Tool->Search Access Control Permission** on the menu to enter the following interface.

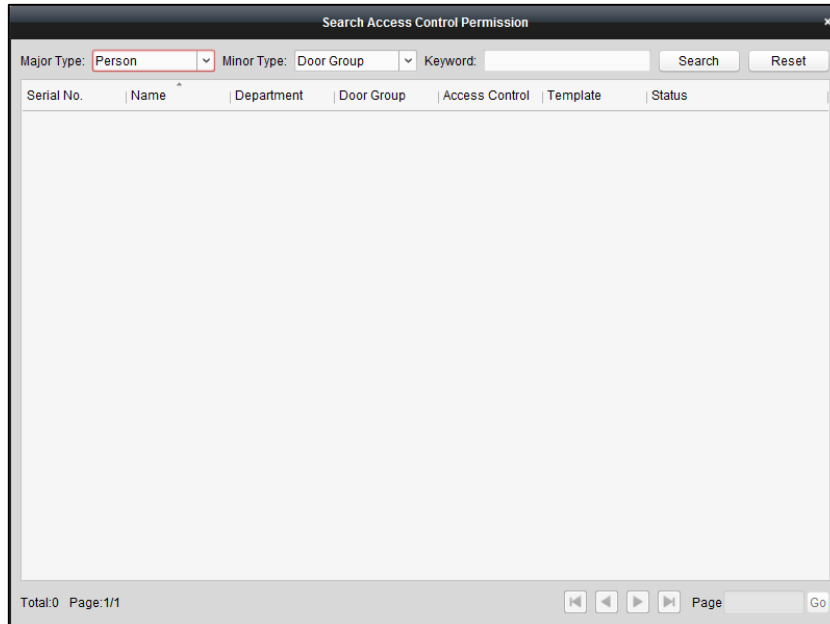

- Set the major type as the main search condition from the dropdown list. You can set it as by person, department, door group, or access control point.
- Set the minor type as the second search condition from the dropdown list. You can set it as by door group or access control point.
- You can also input the keyword of the permission.
- Click **Search** to start searching the result.
- You can click **Reset** the set the search condition to the default value.

7.3.7 Advanced Functions

Purpose:

After configuring the person, card, template, status duration, alarm linkage, and access permission, the advanced functions of the Access Control Client can be configured, such as access control type, authentication password and first card.

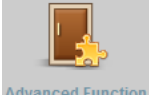

Click **Advanced Function** icon on the control panel to enter the following interface.

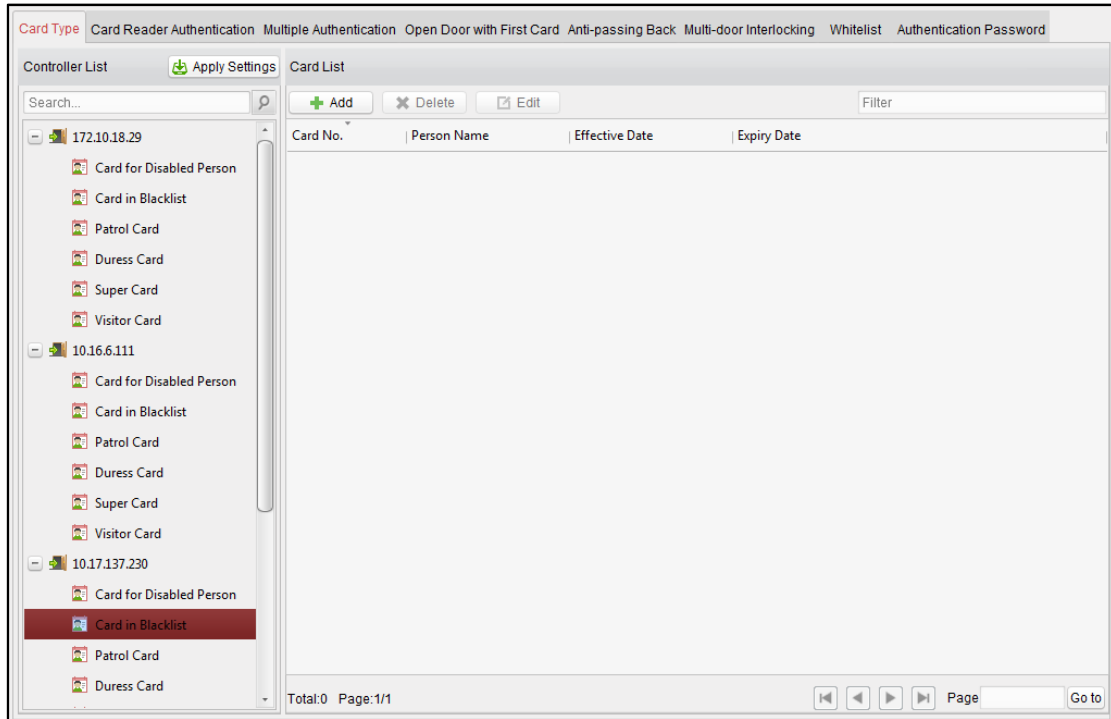

Card Type

Purpose:

The added cards can be assigned with different card type for the corresponding usage.

Note: Please set the card permission and apply the permission setting to the access control device first. For details, refer to *4.6 Permission Configuration*.

Steps:

1. Click **Card Type** tab and select a card type.

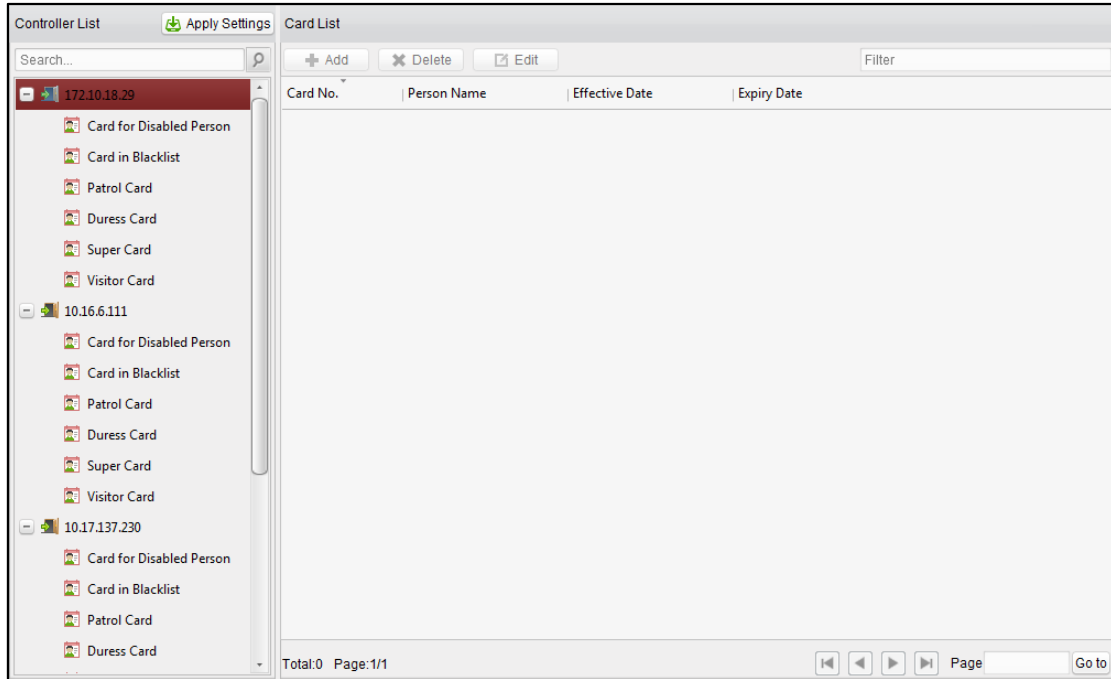

Card for Door Extended Opening: The door will remain open for the configured time period for the card holder.

Card in Blacklist: The card swiping action will be uploaded and the door cannot be opened.

Patrol Card: The card swiping action can be used for checking the working status of the inspection staff. The access permission of the inspection staff is configurable.

Duress Card: The door can be opened by swiping the duress card when there is duress. At the same time, the client can report the duress event.

Super Card: The card is valid for all the doors of the controller during the configured schedule.

Visitor Card: The card is assigned for visitors.

Dismiss Card: The card can be swiped to stop the buzzer of the card reader.

Notes:

- The available card types depend on the access control device type.
- If the card is not assigned as any of the above card types, it is assigned as normal card by default.

2. Click **Add** and select the available card.

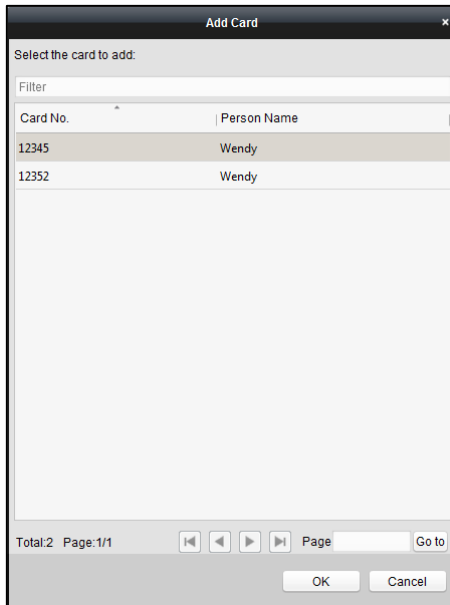

3. Click **OK** to confirm assigning the card(s) to the selected card type.
4. For the Visitor Card, you can click the added card and click **Edit** to edit the Max. Swipe Times, card Effective Time and Expiry Time.

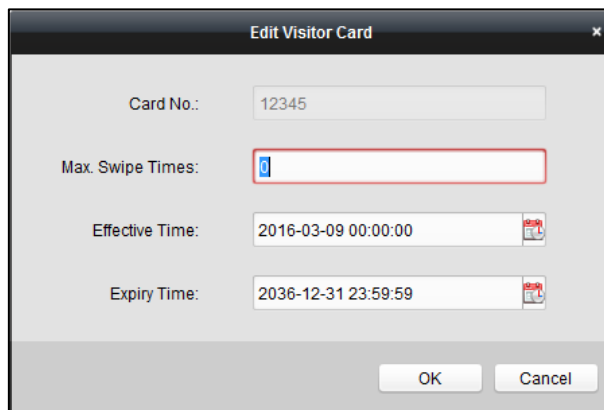

Note: The Max. Swipe Times should be between 0 and 255. When setting as 0, it means the card swiping is unlimited.

5. Click **Apply Settings** button to take effect of the new settings.
6. (Optional) You can click **Delete** to remove the card from the card type and the card can be available for being re-assigned.

Card Reader Authentication

You can set the passing rules for the card reader.

Steps:

1. Click **Card Reader Authentication** tab and select a card reader on the left.
2. Select a card reader authentication mode. The available authentication modes depend on the card reader type:
 - **Card and Password:** The door can open by both inputting the card password and swiping the card.

Note: Here the password refers to the password set when issuing the card. Refer to 4.2.1 Empty Card.
 - **Card or Authentication Password:** The door can open by inputting the authentication password or swiping the card.

Note: Here the authentication password refers to the password set to open the door. Refer to 4.7.8 Multi-door Interlocking

You can set the multi-door interlocking between multiple doors of the same access control device. To open one of the doors, other doors must keep closed. That means in the interlocking combined door group, up to one door can be opened at the same time.

Notes:

- The Multi-door Interlocking function is only supported by the access control device which has more than one access control points (doors).
- Either the anti-passing back or multi-door interlocking function can be configured for an access control device at the same time.

Steps:

1. Click **Multi-door Interlocking** tab and select an access control point from the list.

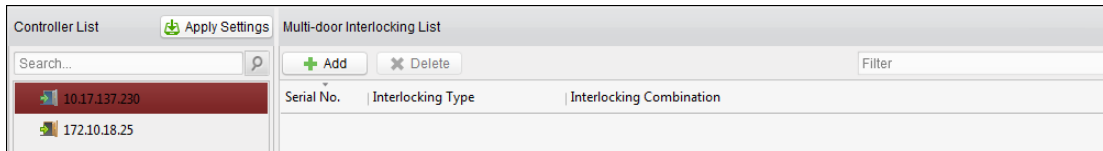

2. Click **Add** to pop up the Add Access Control Point to Interlock interface.

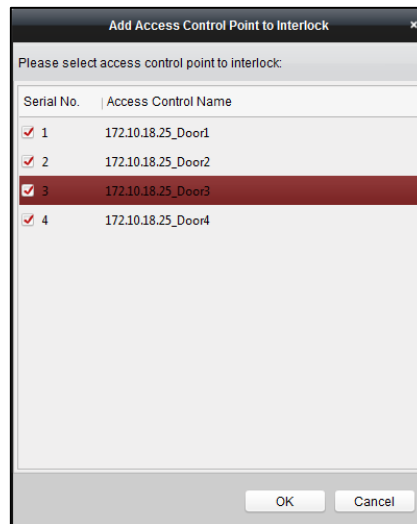

3. Select the access control point (door) from the list.
Note: Up to four doors can be added in one multi-door interlocking combination.
4. Click **OK** to save the adding.
5. (Optional) After adding the multi-door interlocking combination, you can select it from the list and click **Delete** to delete the combination.

Click **Apply Settings** button to take effect of the new settings.

White List

You can add the mobile phone number to the access control device for access permissions. The mobile phone can control the door and the zones by sending SMS control instructions.

Steps:

1. Click the **White List** tab to enter the white list interface.

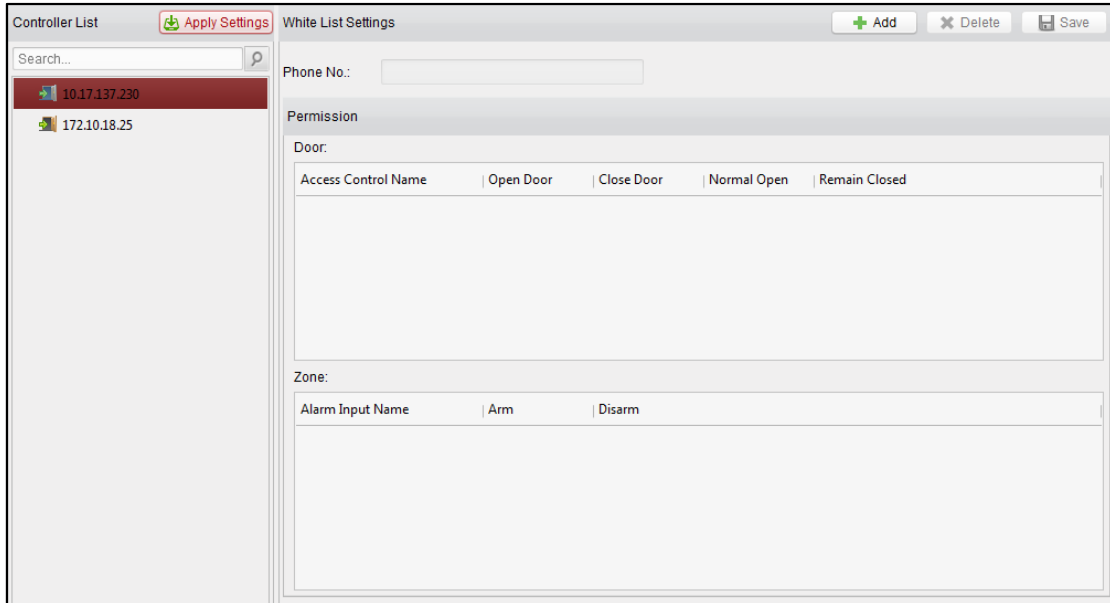

2. Select the access control device from the list and click **Add** button.
3. Input the mobile number.
4. Select the access control permission. You can check the corresponding checkbox to enable the permission.
Door: The mobile can control the door (open, closed, remain open, or remain closed).
Zone: The mobile can arm and disarm the zone.
5. Click **Save** button to save parameters.

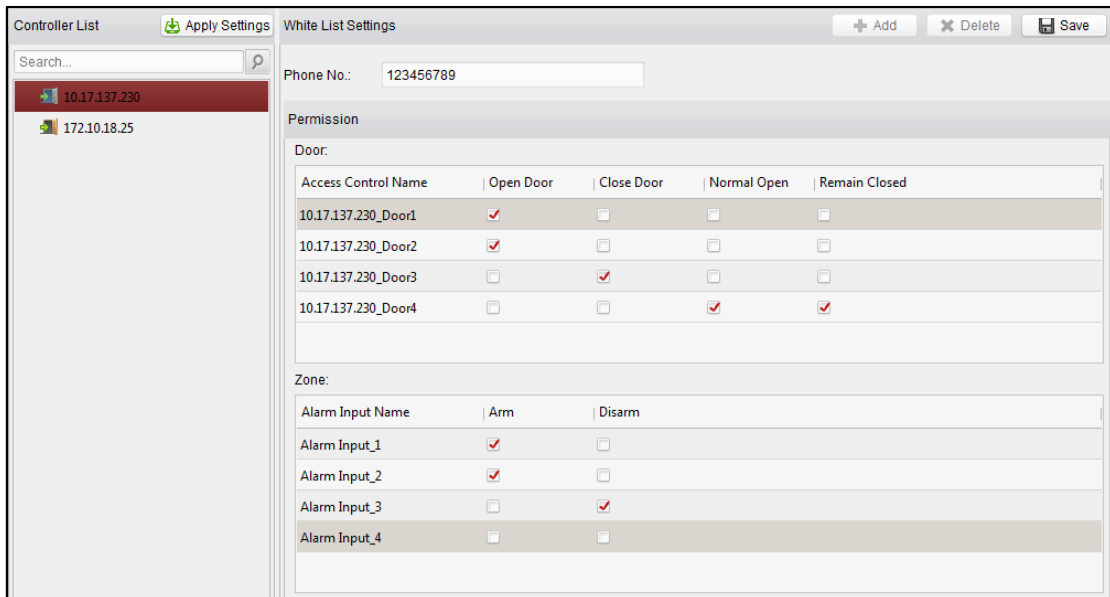

6. You can select the added white list and click **Delete** button to delete it.
7. Click **Apply Settings** button to take effect of the new settings.

Notes:

- Up to 8 white lists can be added for one access control device.
- The mobile can control the door and the zones by sending SMS control instructions. The SMS control instruction is composed of Command, Operation Range, and Operation Object.

Instruction Content	Digit	Description	Format
---------------------	-------	-------------	--------

Command	3	010-Open, 011-Closed, 020-Remain open, 021-Remain Closed, 120-Disarm, 121-Arm	
Operation Range	1	1-all objects with permission, 2-single operation	Command#1#
Operation Object	3	Starts from 1 (corresponding to different doors or arming regions according to commands)	Command#2#Operation Object#

Authentication Password.

- **Fingerprint:** The door can open by only inputting the fingerprint.
- **Card:** The door can open by only swiping the card.
- **Card or Fingerprint:** The door can open by inputting the fingerprint or swiping the card.
- **Password and Fingerprint:** The door can open by both inputting the card password and inputting the fingerprint.

Note: Here the password refers to the password set when issuing the card. Refer to 4.2.1 Empty Card.

- **Card and Fingerprint:** The door can open by both inputting the fingerprint and swiping the card.
- **Card, Password and Fingerprint:** The door can open by both inputting the fingerprint, inputting the card password, and swiping the card.

Note: Here the password refers to the password set when issuing the card. Refer to 4.2.1 Empty Card.

3. Click and drag your mouse on a day to draw a color bar on the schedule, which means in that period of time, the card reader authentication is valid.

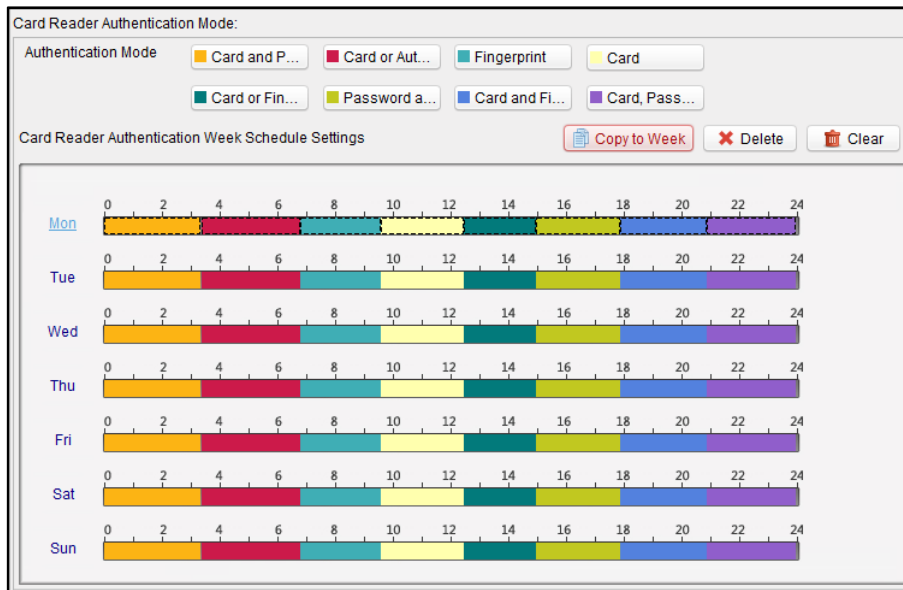

4. Repeat the above step to set other time periods.
Or you can select a configured day and click **Copy to Week** button to copy the same settings to the whole week.
You can click **Delete** button to delete the selected time period or click **Clear** button to delete all the configured time periods.
5. (Optional) Click **Copy to** button to copy the settings to other card readers.

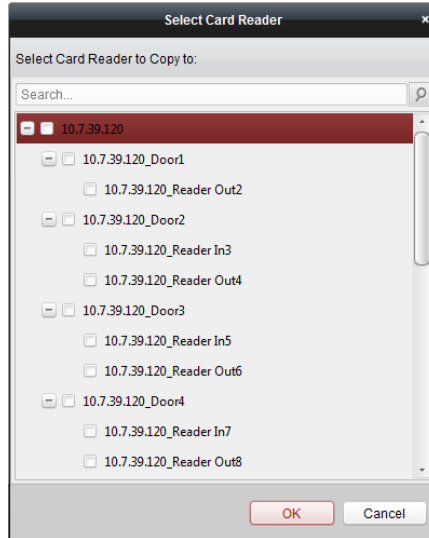

6. Click **Save** button to save parameters.
7. Click **Apply Settings** button to take effect of the new settings.

Multiple Authentication

You can manage the cards by group and set the authentication for multiple cards for one access control point (door).

Note: Please set the card permission and apply the permission setting to the access controller first. For details, refer to *4.6 Permission Configuration*.

Steps:

1. Click **Multiple Authentication** tab and select an access control point (door) from the list on the left.
2. Click **Add Authentication Group** button to pop up the following interface:

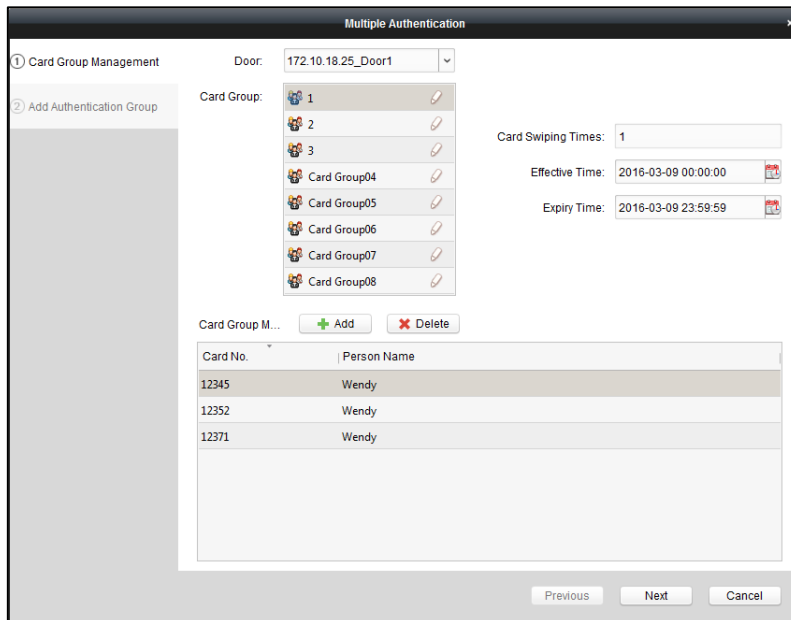

3. Click the card group from the list, and **Add** to select the card to add the card group.
Note: Please set the card permission and apply the permission setting to the access control device first. For details, refer to *4.6 Permission Configuration*.
 You can click  of the card group to edit the group name.
4. Input the **Card Swiping Times** for the selected card group.

Notes:

- The Card Swiping Times should be larger than 0 and smaller than the added card number in the card group.
 - The upper limit of Card Swiping Times is 16.
5. Select the effective time and expiry time for the selected card group.
- Note:** You can also click **Card Group Management** button on the Multiple Authentication tab page to set the card group.
6. Click **Next** to enter the Add Authentication Group interface.

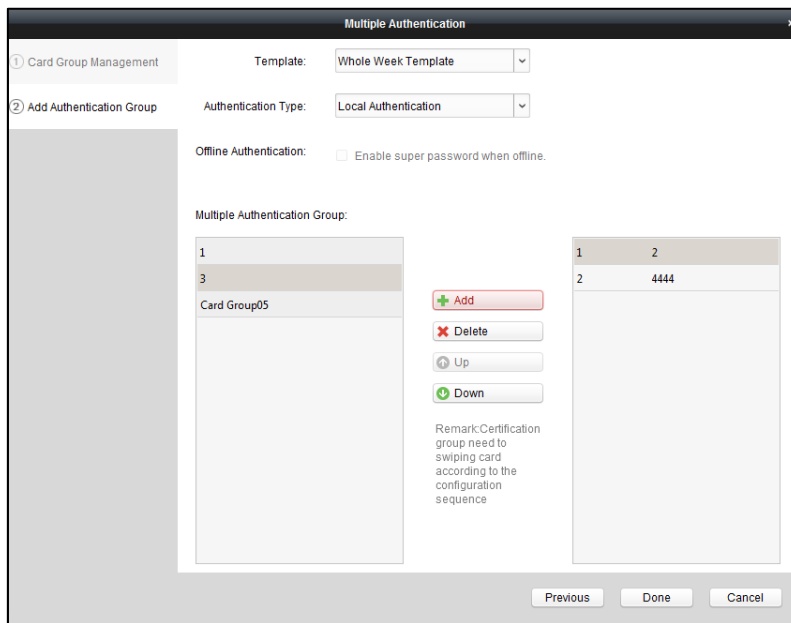

7. Select the template of the authentication group from the dropdown list. For details about setting the template, refer to *4.3 Schedule Template*.
8. Select the authentication type of the authentication group from the dropdown list.
- **Local Authentication:** Authentication by the access control device.
 - **Local Authentication and Remotely Open Door:** Authentication by the access control device and by the client.
For Local Authentication and Remotely Open Door type, you can check the checkbox to enable the super password authentication when the access control device is disconnected with the client.
 - **Local Authentication and Super Password:** Authentication by the access control device and by the super password.
9. In the list on the left, the card group name will be displayed. You can click the card group and click **Add** to add the group to the authentication group.
You can click the added card group and click **Delete** to remove it from the authentication group.
You can also click **Up** or **Down** to set the card swiping order.
10. Click **Done** to save the settings.
11. Click **Apply Settings** button to take effect of the new settings.

Notes:

- For each access control point (door), up to four authentication groups can be added.
- For the authentication group which certificate type is **Local Authentication**, up to 8 card groups can be added to the authentication group.
- For the authentication group which certificate type is **Local Authentication and Super Password** or **Local Authentication and Remotely Open Door**, up to 7 card groups can be added to the authentication group.

Open Door with First Card

Purpose:

The door remains open for the configured time duration after the first card swiping until the remain open duration ends.

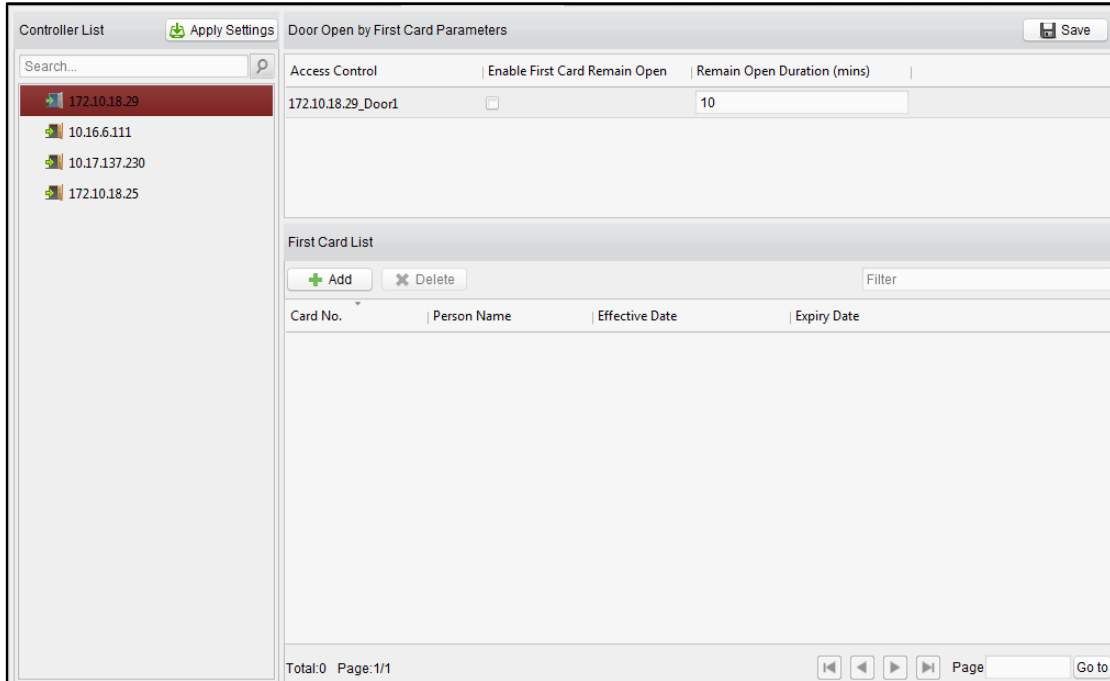

Steps:

1. Click **Open Door with First Card** tab and select an access control device from the list on the left.
 2. Check the checkbox of **Enable First Card Remain Open** to enable this function.
 3. In the **Remain Open Duration** (min), input the time duration for remaining open the door.
- Note:** The Remain Open Duration should be between 0 and 1440 minutes. By default, it is 10 minutes.
4. In the First Card list, Click **Add** button to pop up the following dialog box.

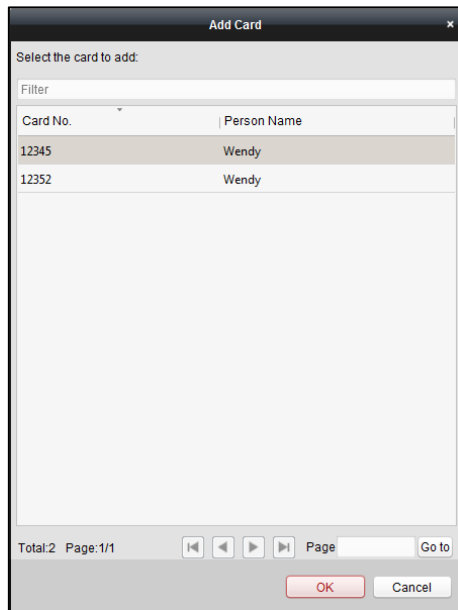

- 1) Select the cards to add as first card for the door and click **OK** button.

Note: Please set the card permission and apply the permission setting to the access control device first. For details, refer to *4.6 Permission Configuration*.

- 2) You can click **Delete** button to remove the card from the first card list.
5. Click **Save** and then click **Apply Settings** button to take effect of the new settings.

Anti-Passing Back

Purpose:

You can set to only pass the access control point according to the specified path and only one person could pass the access control point after swiping the card.

Notes:

- Either the anti-passing back or multi-door interlocking function can be configured for an access control device at the same time.
- You should enable the anti-passing back function on the access control device first.

Setting the Path of Swiping Card (Card Reader Order)

Steps:

1. Click **Anti-passing Back** tab and select an access control point.

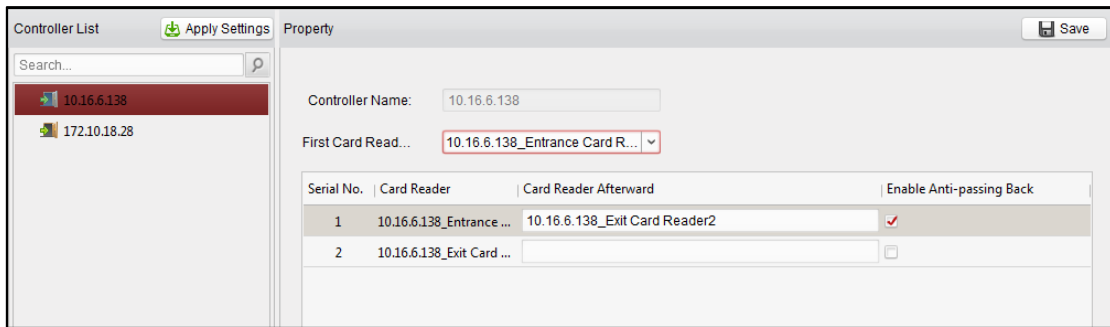

2. You can select the card reader as the beginning of the path.
3. In the list, click the text filed of **Card Reader Afterward** and select the linked card readers.

Example: If you select Reader In_01 as the beginning, and select Reader In_02, Reader Out_04 as the linked card readers. Then you can only get through the access control point by swiping the card in the order as Reader In_01, Reader In_02 and Reader Out_04.

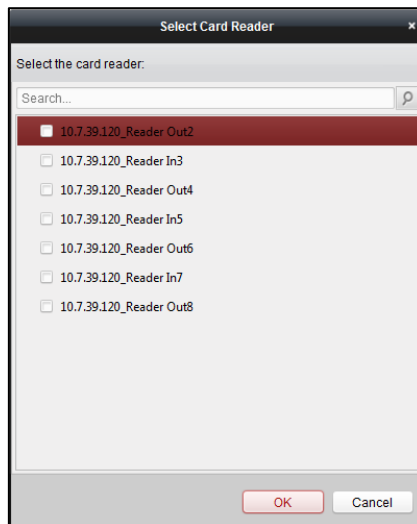

Note: Up to four afterward card readers can be added for one card reader.

4. Check the **Enable Anti-Passing Back** checkbox to enable the anti-passing back function of the card reader.
5. (Optional) You can enter the Select Card Reader dialog box again to edit its afterward card readers.
6. Click **Save** and then click **Apply Settings** button to take effect of the new settings.

Multi-door Interlocking

You can set the multi-door interlocking between multiple doors of the same access control device. To open one of the doors, other doors must keep closed. That means in the interlocking combined door group, up to one door can be opened at the same time.

Notes:

- The Multi-door Interlocking function is only supported by the access control device which has more than one access control points (doors).
- Either the anti-passing back or multi-door interlocking function can be configured for an access control device at the same time.

Steps:

6. Click **Multi-door Interlocking** tab and select an access control point from the list.



7. Click **Add** to pop up the Add Access Control Point to Interlock interface.

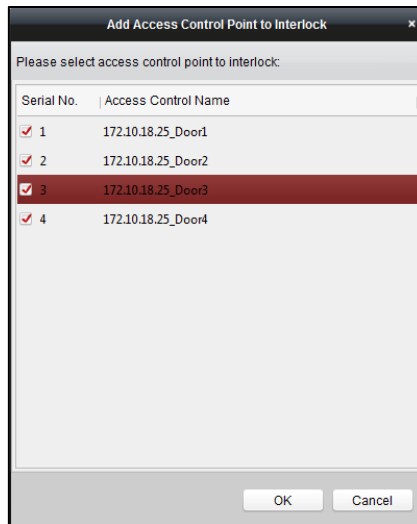

8. Select the access control point (door) from the list.

Note: Up to four doors can be added in one multi-door interlocking combination.

9. Click **OK** to save the adding.

10. (Optional) After adding the multi-door interlocking combination, you can select it from the list and click **Delete** to delete the combination.

Click **Apply Settings** button to take effect of the new settings.

White List

You can add the mobile phone number to the access control device for access permissions. The mobile phone can control the door and the zones by sending SMS control instructions.

Steps:

8. Click the **White List** tab to enter the white list interface.

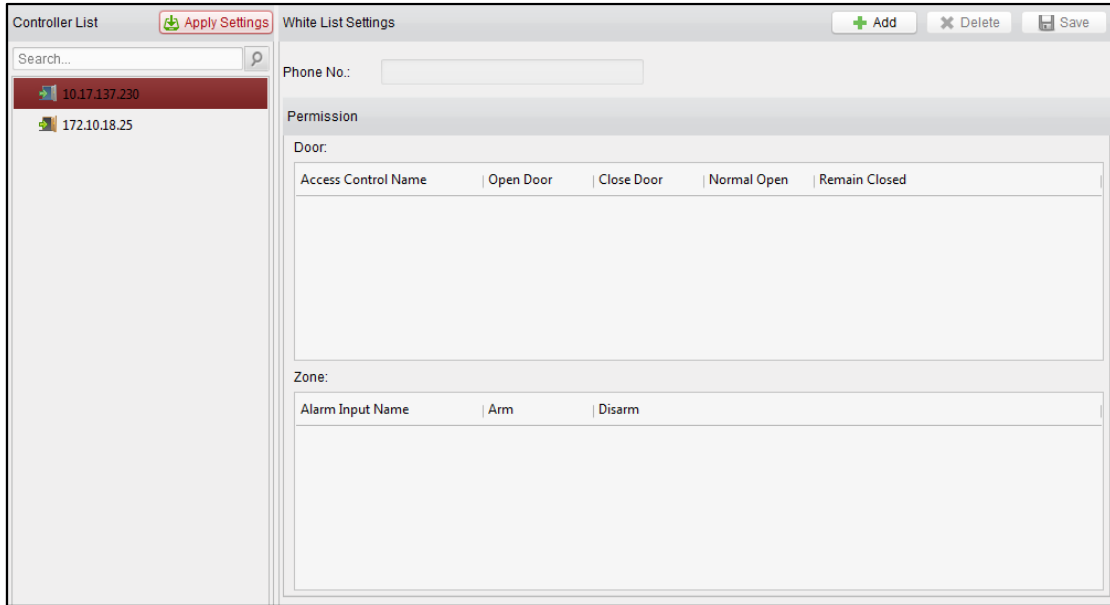

9. Select the access control device from the list and click **Add** button.
10. Input the mobile number.
11. Select the access control permission. You can check the corresponding checkbox to enable the permission.
Door: The mobile can control the door (open, closed, remain open, or remain closed).
Zone: The mobile can arm and disarm the zone.
12. Click **Save** button to save parameters.

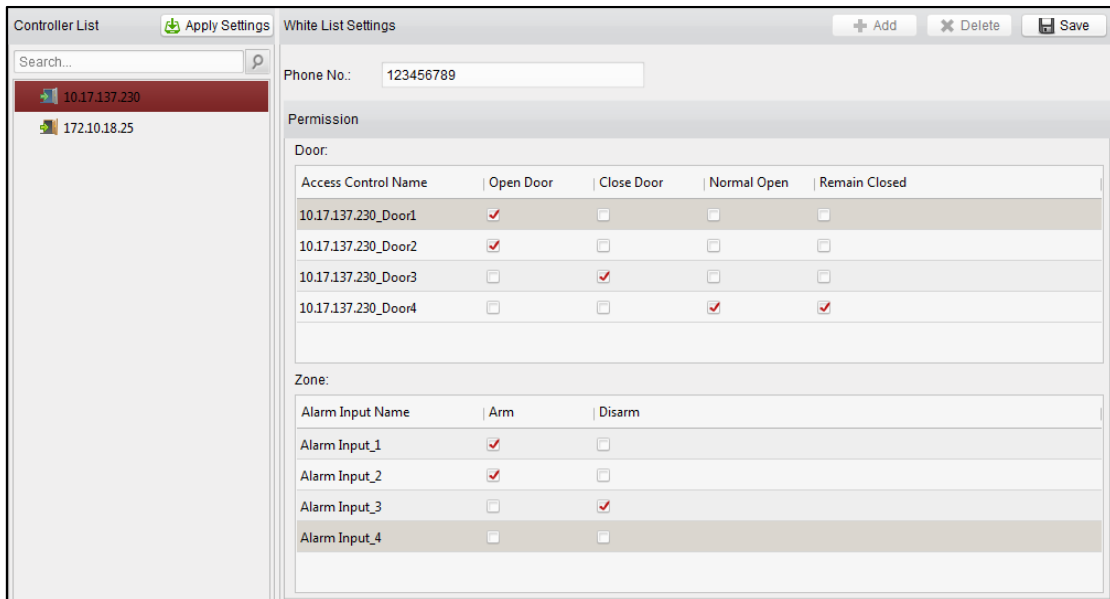

13. You can select the added white list and click **Delete** button to delete it.
14. Click **Apply Settings** button to take effect of the new settings.

Notes:

- Up to 8 white lists can be added for one access control device.
- The mobile can control the door and the zones by sending SMS control instructions. The SMS control instruction is composed of Command, Operation Range, and Operation Object.

Instruction Content	Digit	Description	Format
---------------------	-------	-------------	--------

Command	3	010-Open, 011-Closed, 020-Remain open, 021-Remain Closed, 120-Disarm, 121-Arm	
Operation Range	1	1-all objects with permission, 2-single operation	Command#1#
Operation Object	3	Starts from 1 (corresponding to different doors or arming regions according to commands)	Command#2#Operation Object#

Authentication Password

Purpose:

You can open the door by inputting the authentication password on the card reader keypad after finishing the operation of setting authentication password.

Notes:

- This authentication password function is only valid during the schedules when the card reader authentication mode for the access control device is set as **Card or Authentication Password**. For details, please refer to 4.7.2 *Card Reader Authentication*.
- This function should be supported by the access control device.

Steps:

1. Click **Authentication Password** tab and select an access control device from the list.

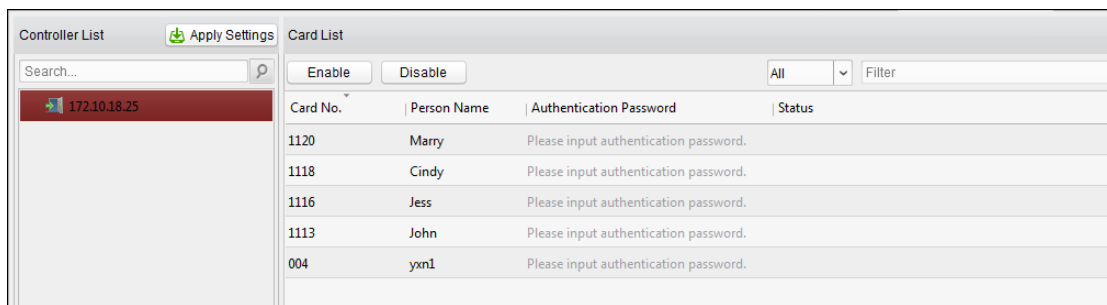

All the cards and persons which have been applied to the device will be displayed.

2. Click the **Authentication Password** field of the card and input the authentication password for the card.

Note: The authentication password should contain 4 to 8 digits.

3. After setting the authentication password, the authentication password function of the card will be enabled by default.

You can click **Disable** to disable the card’s authentication password.

You can also click **Enable** to enable it again.

4. (Optional) You can input the keywords of card No., person name, or authentication password to search.

You can also set the condition to filter the cards which have enabled the authentication password function and the cards which haven’t.

Note: Up to 500 cards with authentication password can be added to one access control device. The password should be unique and cannot be same with each other.

7.4 Event and Alarm Management

Purpose:

In this section, you are able to check the real-time events and alarms, and view the event report of the access control point.

7.4.1 Real-Time Access Control Event and Alarm

Purpose:

You can view the real-time alarm and event information received by the client.

Before you start:

Before you can receive the alarm information from the device, you need to click **Tool -> Arming Settings** and arm the device by checking the corresponding checkbox.

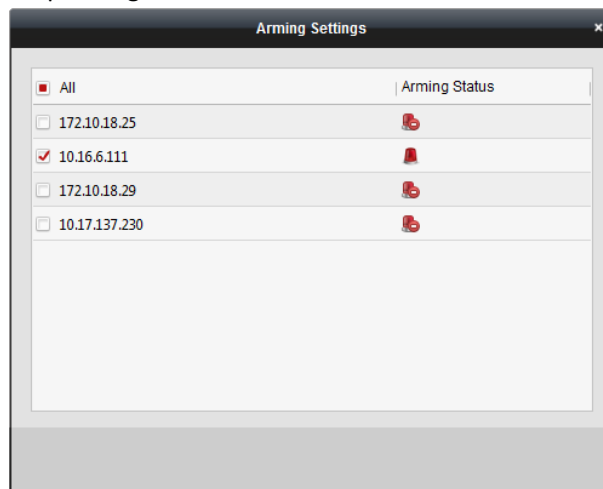

Note: The device will be armed by default after being added to the client.

After enabling the arming control of the access control device, the client can receive the alarms and events once triggered.

Click the icon in Alarms and Events Toolbar to show the Alarms and Events panel. Or click to display the Alarm Event interface.

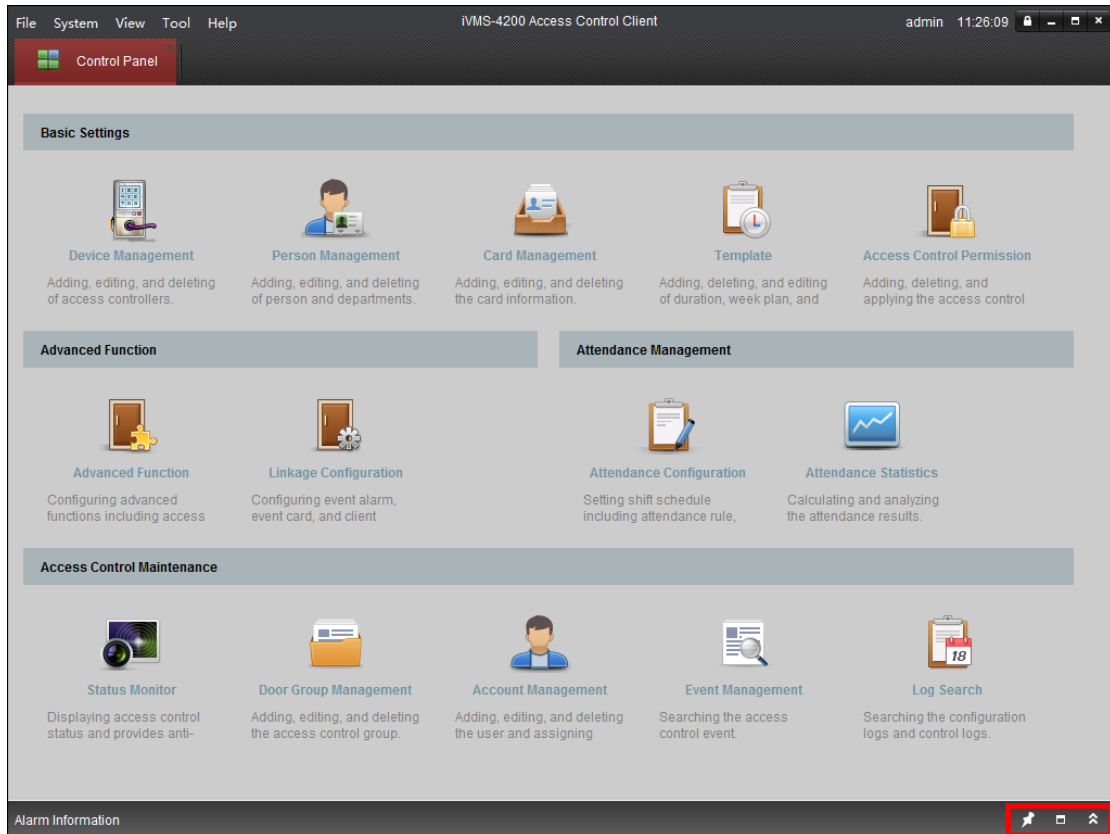

You can view real-time access event (such as swiping to open the door, unrecognized card number, duration group error, etc.) information and other operation events in Alarm Event interface.

Note: If you cannot receive the event and alarm information of the access control device, you can check the arming status of the device in **Tool -> Arming Settings**.

Serial No.	Event Type	Card Holder	Card Type	Card No.	Event Time	Event Source	Capture	Direction
20	No card No.			2929558121	2016-08-19 13:5...	10.16.6.138_Entrance Card Reader1		Enter
19	No card No.			0916181063	2016-08-19 13:5...	10.16.6.138_Entrance Card Reader1		Enter
18	No card No.			45321	2016-08-19 13:5...	10.16.6.138_Entrance Card Reader1		Enter
17	No card No.			1234	2016-08-19 13:5...	10.16.6.138_Entrance Card Reader1		Enter
16	Remotely Arming				2016-08-19 13:0...	10.16.6.138		
15	Remotely Login				2016-08-19 13:0...	10.16.6.138		
14	Device Tampering ...				2016-08-19 13:0...	10.16.6.138		
13	External Power Sup...				2016-08-19 13:0...	10.16.6.138		
12	Device Tampering ...				2016-08-04 09:5...	10.16.6.138		
11	External Power Sup...				2016-08-04 09:5...	10.16.6.138		

You can click the card swiping event to view the card holder information.

You can click to view the captured alarm pictures if the storage server is configured. For configuring the storage server, please refer to **8.4.4 Storage Server Configuration**.

7.4.2 Event Management

Purpose:

You can search historical access event according to the search conditions (such as event type, name of the person, card No. or start/end time).



Click **Event Management** icon on the control panel to enter the interface.

The screenshot displays the software interface for a Video Access Control Terminal. It is divided into several sections:

- Search Filters:** Located at the top left, it includes radio buttons for 'Source' (Client selected, Device unselected), a 'Device' dropdown menu (Video Access Control Terminal), a 'Capture' checkbox (With Picture unselected), an 'Event Type' dropdown (All), 'Start Time' (2016-12-14 00:00:00), 'End Time' (2016-12-14 23:59:59), 'Card Holder Name', 'Card No.', and 'Card Type' dropdowns. A 'Search' button is positioned to the right of these filters.
- Search Result:** A table with columns: Serial ..., Event Type, Card Holder, Card Type, Card No., Event Time, Event Source, and Capture. The table is currently empty. An 'Export' button is located at the top right of this section.
- Card Holder Information:** A panel on the right side containing a placeholder for a person's photo and several input fields for: Person No., Name, Gender, ID Type, ID No., Department, Phone No., and Address.
- Footer:** At the bottom left, it shows 'Total:0 Page:1/1'. At the bottom center, there are navigation arrows and a 'Page' field with a 'Go to' button.

Steps:

1. Select the source.
You can select Client or Device.
2. Enter the search condition (source, event type/card holder name/card No./capture/start & end time).
3. Click **Search** to get the search results.
4. View the event information in the event list.
5. Click an event to view the information of the card holder on the **Card Holder Information** panel on the left side of the page.
6. You can click **Export** button to export the search results to the local PC.

7.5 System Maintenance

7.5.1 Log Management

Purpose:

The log files of the Access Control Client and the devices that connected to the Access Control Client can be searched for checking.



Click **Log Search** icon on the control panel to open the Log Search page.

Serial No.	Operation Type	Time	Content
5	Data Import/Export	2016-03-21 11:10:02	Export Person
6	Data Import/Export	2016-03-21 10:25:19	Export Person and Card Information.
7	Data Import/Export	2016-03-21 10:20:14	Export Person and Card Information.
8	Login	2016-03-21 09:39:56	User Login
9	Login	2016-03-20 18:06:20	Logout
10	Data Import/Export	2016-03-20 18:02:23	Export Person and Card Information.
11	Login	2016-03-20 15:06:52	User Login
12	Login	2016-03-20 15:04:43	Logout
13	Man-Hour Shift	2016-03-20 12:48:21	Add Man-Hour Attendance Shift:man
14	Normal Shift	2016-03-20 12:15:52	Add Normal Attendance Shift:00111
15	Attendance Rule	2016-03-20 12:15:28	Add Normal Shift Attendance Rule:1212
16	Password Authentication	2016-03-20 11:51:31	Download Password Authentication
17	Password Authentication	2016-03-20 11:51:27	Add Password Authentication:12373
18	Card Reader Autentication	2016-03-20 11:51:11	Save Card Reader Permission
19	Card Reader Autentication	2016-03-20 11:51:02	Card reader authentication downloading operation
20	Card Reader Autentication	2016-03-20 11:50:55	Copied the card reader authentication
21	Login	2016-03-20 11:29:21	User Login
22	Login	2016-03-20 11:28:19	Logout
23	Login	2016-03-20 11:24:50	User Login

Searching Configuration Logs

Purpose:

The operation logs via the Access Control Client can be searched by time.

Steps:

1. Open the Log Search page.
2. Select the radio button of Configuration Logs.
3. Select the Operation Type of log files. For cofiguration log, the operation type includes department management, card managemene, access control permission configuration, ect..
4. Click to specify the start time and end time.
5. Click **Search**. The matched log files will display on the right.

You can check the operation time, log type and other information of the logs.

6. You can click **Export** to export the search result to the local PC.

Note: Please narrow the search condition if there are too many log files.

Searching Control Logs

Purpose:

The logs of controlling access control point via the client can be searched by time.

Steps:

1. Open the Log Search page.

2. Select the radio button of Control Logs.
3. Select the Operation Type of log files. For control log, the operation type includes opening door, closing door, remaining open, remaining closed, and capture.
4. Click  to specify the start time and end time.
5. Click **Search**. The matched log files will display on the right.

You can check the operation time, log type and other information of the logs.

6. You can click **Export** to export the search result to the local PC.

Note: Please narrow the search condition if there are too many log files.

7.5.2 Account Management

Purpose:

Multiple user accounts can be added to the client software, and you are allowed to assign different permissions for different users if needed.



Click **Account Management** icon on the control panel to open the Account Management page.

User List			
<input type="button" value="+ Add"/> <input type="button" value="Modify"/> <input type="button" value="Delete"/>			
Index	User Name	Type	Remark
1	admin	Super User	Super user. Cannot be deleted.

Note: The user account you registered to log in to the software is set as the super user.

Adding the User

Steps:

1. Open the Account Management page.
2. Click **Add** to open the Add User dialog box.
3. Input the user name, password and confirm password as desired. The software will judge password strength automatically, and we highly recommend you to use a strong password to ensure your data security.
4. Check the checkboxes to assign the permissions for the created user.
5. Click **OK** to save the settings.

Note: Up to 16 user accounts can be added to the client.

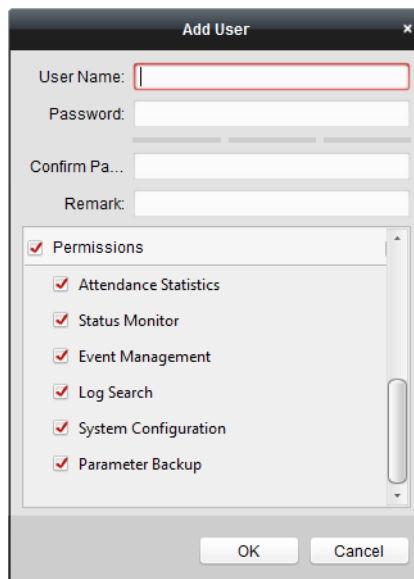



- ◆ A user name cannot contain any of the following characters: / \ : * ? " < > | . And the length of the password cannot be less than 8 characters.
- ◆ For your privacy, we strongly recommend changing the password to something of your own choosing (using a minimum of 8 characters, including upper case letters, lower case letters, numbers, and special characters) in order to increase the security of your product.
- ◆ Proper configuration of all passwords and other security settings is the responsibility of the installer and/or end-user.

Managing the User

Purpose:

After created successfully, the user account is added to the user list on the Account Management page. You can edit or delete the information of the user accounts.

To edit the information of the user, select the user from the list, and click **Modify**.

To delete the information of the user, select the user from the list, and click **Delete**.

Note: The super user cannot be deleted and its permission cannot be modified.

7.5.3 Auto Backup Settings

Purpose:

You can set to enable the auto backup function to back up the client database automatically such as person, attendance data, permission data, etc.

Steps:

1. Click **System** -> **Auto Backup** to open the Auto Backup window as follows.

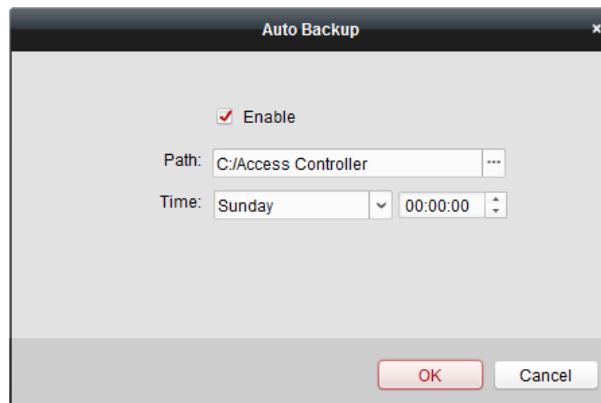

2. Check the **Enable** checkbox to enable the Auto Backup function.
3. Click to set the path for saving the backed file.
4. Set the date and time for backing up the database.
5. Click **OK** to save the settings.

7.5.4 System Configuration

Purpose:

The general parameters, card reader, fingerprint machine, and storage server can be configured.

General Settings

Steps:

1. Click **Tool**->**System Configuration** to open the System Configuration page.

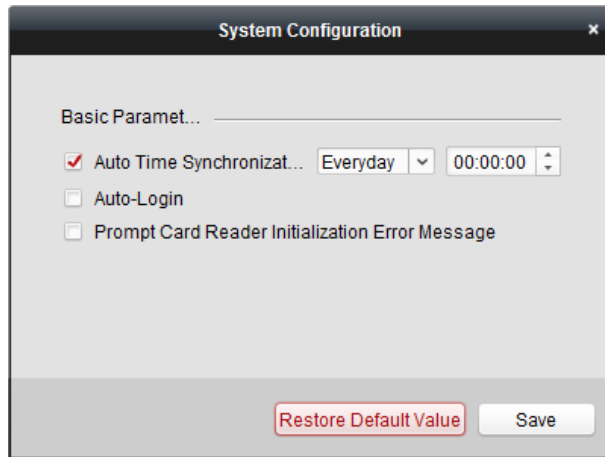

2. Check the checkbox to enable Automatic Time Synchronization.
The Automatic Time Synchronization can operate auto time adjustment to all access control devices added to the Access Control Client according to specified period and time.
Select the matched day and input the time to operate the time adjustment.
3. You can check the checkbox to enable auto-login.
4. You can click the checkbox to enable the message prompt when the card reader initialization is error.
5. Click **Save** button to save the settings.

Note: You can click **Restore Default Value** button to restore the defaults of the general settings.

Card Reader Configuration

Purpose:

The Card Reader should connect with the PC running the client to read the card No..
You should configure the card reader before setting the card.

Note: Currently, the supported card reader types include DS-K1F100-D8, DS-K1F100-M, and DS-K1F100-D8E.

Steps:

1. Click **Tool->Card Reader** on the menu to pop up the card reader configuration dialog box.

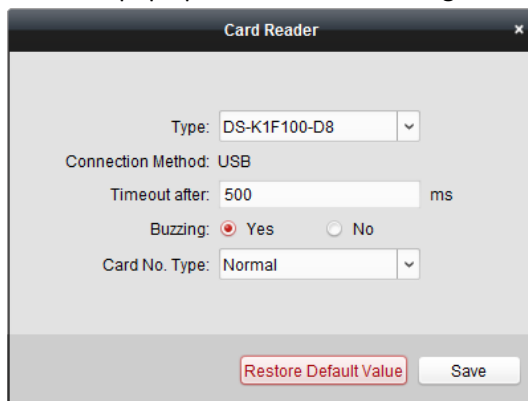

2. Set the parameters about the connected card reader.
3. Click **Save** button to save the settings.
You can click **Restore Default Value** button to restore the defaults.

Fingerprint Machine Configuration

The fingerprint machine should connect with the PC running the client for collecting the fingerprint.

Steps:

1. Click **Tool->Fingerprint Machine** on the menu to open the Fingerprint Machine Configuration page.

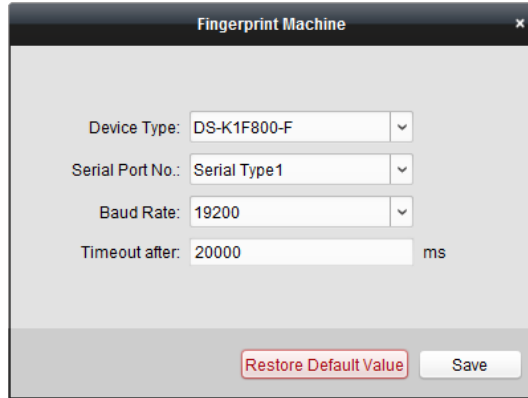

2. Select the device type.
Currently, the supported fingerprint machine types include DS-K1F800-F, DS-K1F300-F, and DS-K1F810-F.
3. For fingerprint machine type DS-K1F800-F, you can set the serial port number, baud rate, and overtime parameters of the fingerprint machine.
4. Click **Save** button to save the settings.
You can click **Restore Default Value** button to restore the default settings.

Notes:

- The serial port number should correspond to the serial port number of PC.
- The baud rate should be set according to the external fingerprint card reader. The default value is 19200.
- Overtime refers to the valid fingerprint collecting time. If the user does not input a fingerprint or inputs a fingerprint unsuccessfully, the device will indicate that the fingerprint collecting is over.

Storage Server Configuration

You should configure the storage server before capturing the pictures for the storage of captured pictures.

Steps:

1. Click **Tool->Storage Server** on the menu to enter the storage server configuration interface.

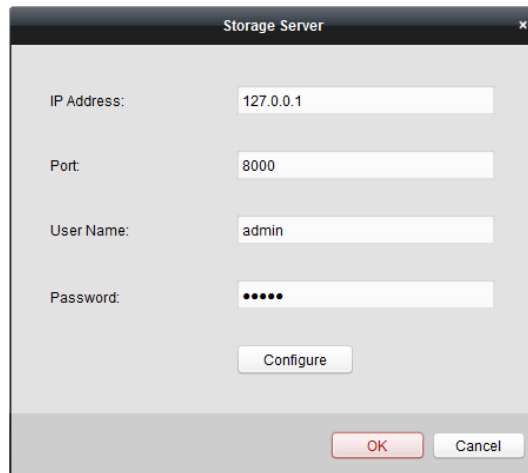

2. Input the storage server parameters including IP address, port No., user name, and password.
3. Click **Configure** button to enter the Remote Configuration interface as follows.

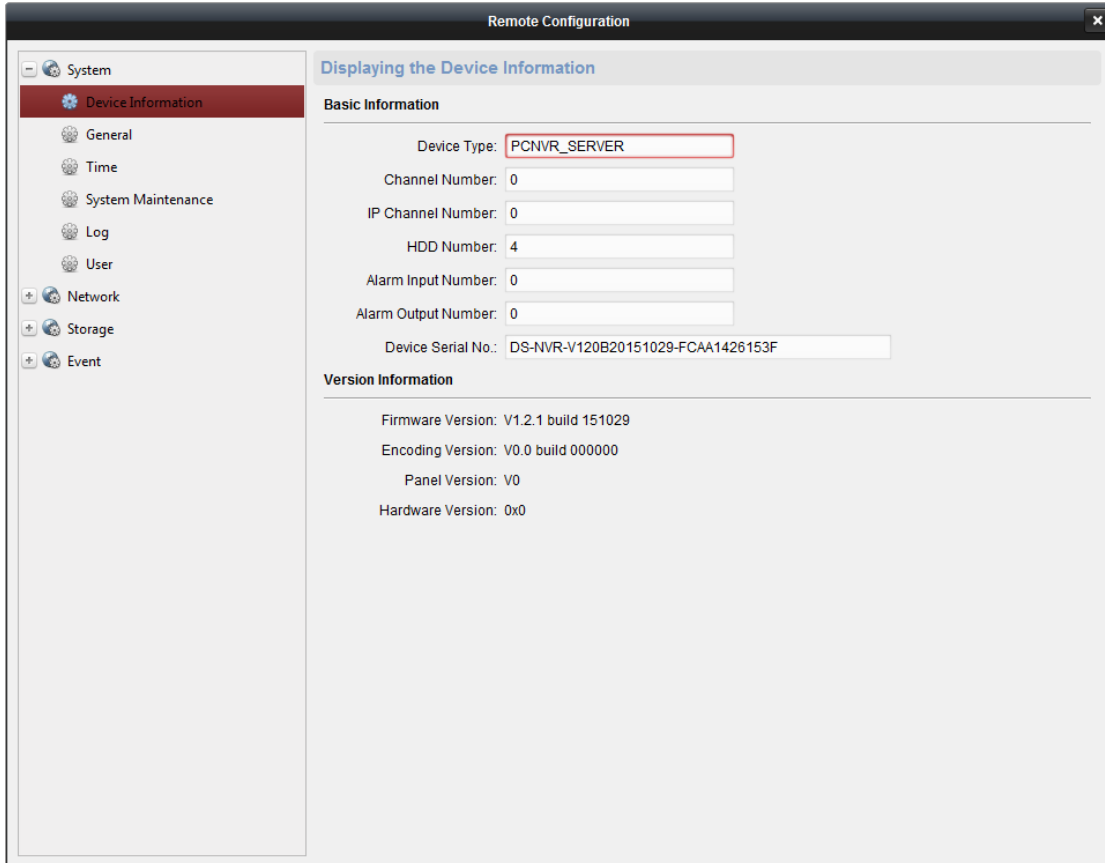

4. The HDDs of the storage server need to be formatted for the video file and picture storage.
 - 1) Click **Storage->General**, to enter the HDD Formatting interface.
 - 2) Select the HDD from the list and click **Format**. You can check the formatting process from the process bar and the status of the formatted HDD changes from *Unformatted* to *Normal Status*.

Note: Formatting the HDDs is to pre-allocate the disk space for storage and the original data of the formatted HDDs will not be deleted.

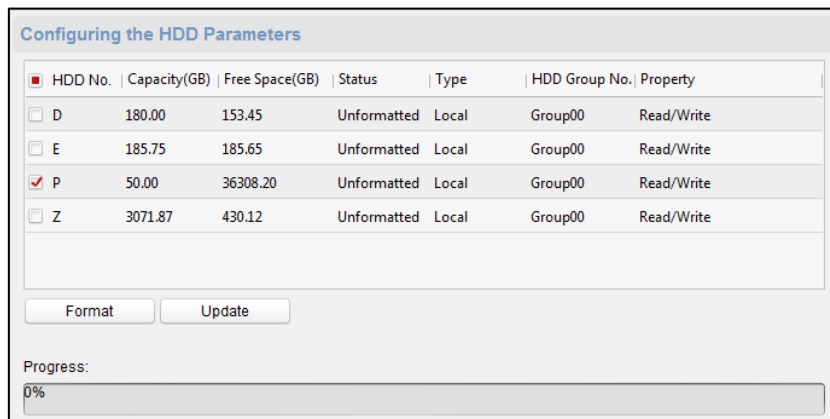

5. After formatting of the HDD, you can set the picture storage quota in the Remote Configuration interface.

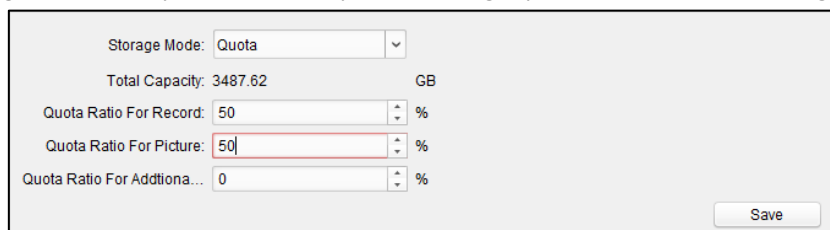

Click **Save** to save the storage server remote configuration settings.

6. After formatting the HDD and setting the quota, click **OK** to save the settings.

8 iVMS-4200 Control Client Operation

8.1 Importing Access Control Device

Before you start:

- Make sure iVMS-4200 Control Client is installed on your local PC.
- Make sure iVMS-4200 Access Control Client has added Video Access Control Terminal.
- Make sure iVMS-4200 Access Control Client is running.

Steps:

1. In the iVMS-4200 Control Client control panel, click **System** -> **Import from Access Control Client**.

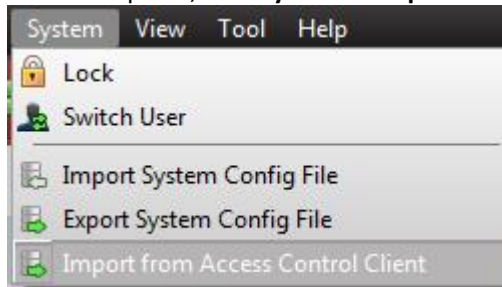

2. Input the iVMS-4200 Access Control Client login user name and password in the pop-up window.
3. Click **Start Synchronization**.

All devices in the iVMS-4200 Access Control Client will import to this client.

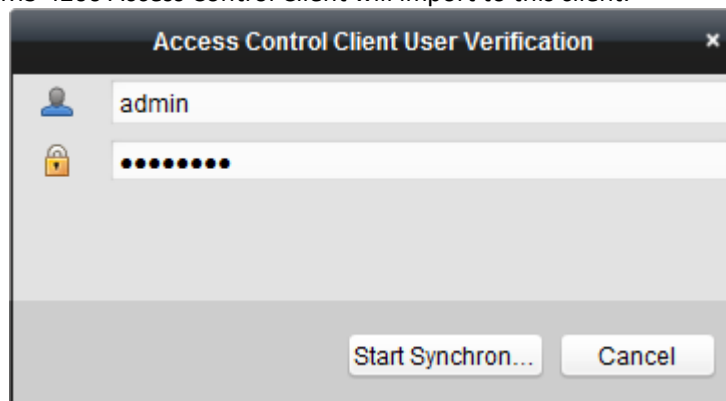

8.2 Live View and Playback Settings

Purpose:

The parameters for live view and playback, including picture format, pre-play duration, etc., can be set.

Steps:

1. Open the System Configuration page.
2. Click the **Live View and Playback** tab to enter the Live View and Playback Parameter Settings interface.
3. Configure the live view and playback parameters. For details, see *Table 8-1 Live View and Playback Parameters*.
4. Click **Save** to save the settings.

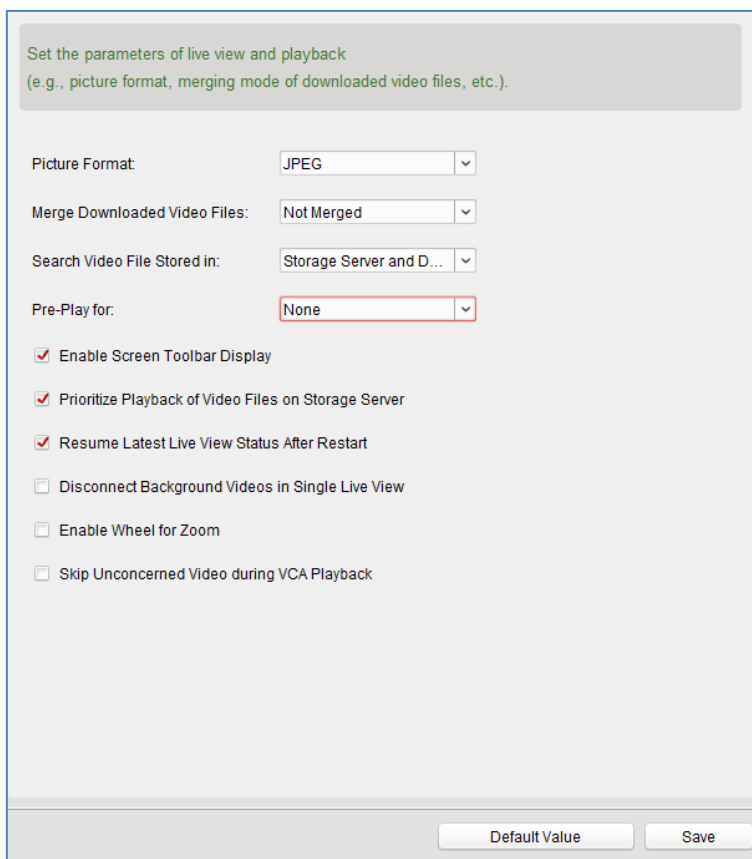

Table 8-1 Live View and Playback Parameters

Parameters	Description
Picture Format	Set the file format for the captured pictures during live view or playback.
Merge Downloaded Video Files	San set the maximum size of merged video file for downloading the video file by date.
Search Video Files Stored in	Set to search the video files stored in the local device, in the storage server, or both in the storage server and local device for playback.
Pre-play for	Set the pre-play time for event playback. Note: You should set it as None to check the live view and the playback.
Enable Screen Toolbar Display	Show the toolbar on each display window in live view or playback.
Prioritize Playback of Video Files on Storage Server	Play back the video files recorded on the storage server preferentially. Otherwise, play back the video files recorded on the local device.
Resume Latest Live View Status After Restart	Resume the latest live view status after you log into the client again.
Disconnect Background Videos in Single Live View	In multiple-window division mode, double-click a live video to display it in 1-window division mode, and the other live videos will be stopped for saving the resource.
Enable Wheel for Zoom	Enable to use the mouse wheel for zoom in or out of the video in PTZ mode, or for zoom in or restoring of the video in digital zoom mode. In this

	way, you can directly zoom in or out (or restore) the live video by scrolling the mouse.
Skip Unconcerned Video during VCA Playback	Enable to skip the unconcerned video during VCA playback and the unconcerned video won't be played during VCA playback.

8.3 Group Management

Purpose:

The devices added should be organized into groups for a convenient management. You can get the live view, play back the video files, and do some other operations of the device through the group.

Before you start:

Devices need to be added to the client software for group management.

Perform the following steps to enter the Group Management interface:

1. Open the Device Management page.
2. Click the **Group** tab to enter the Group Management interface.

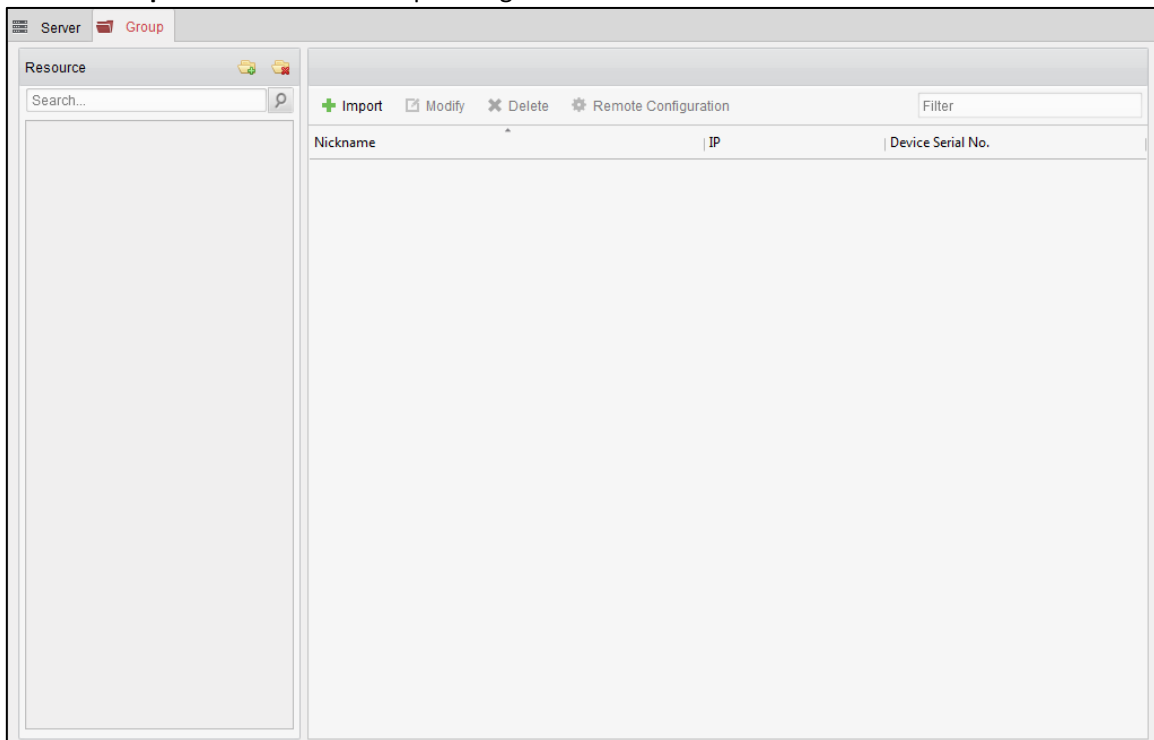

8.3.1 Adding the Group

Steps:

1. Click  to open the Add Group dialog box.
2. Input a group name as you want.
3. Click **OK** to add the new group to the group list.

You can also check the checkbox **Create Group by Device Name** to create the new group by the name of the selected device.

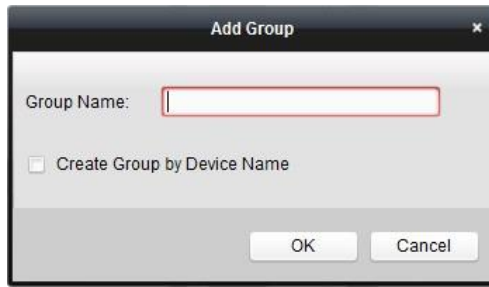

8.3.2 Importing Encoding Device to Group

Steps:



1. Click **Import** on Group Management interface, and then click the **Encoding Channel** tab to open the Import Encoding Channel page.
 You can also select **Alarm Input** tab and import the alarm inputs to the group.
 You can also select **Access Control** tab and import the access control device to the group.
2. Select the thumbnails/names of the cameras in the thumbnail/list view.
3. Select a group from the group list.
4. Click **Import** to import the selected cameras to the group.
 You can also click **Import All** to import all the cameras to a selected group.

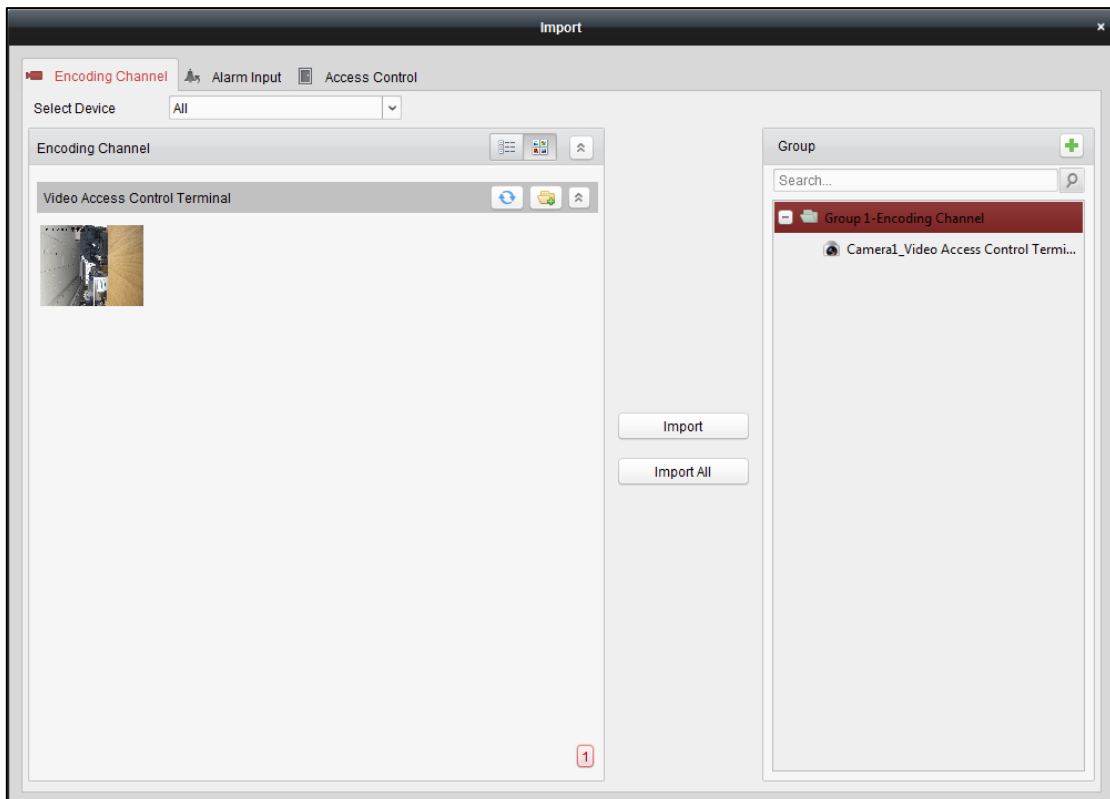

Notes:

- You can also click the icon  on the Import Encoding Channel page to add a new group.
- Up to 256 cameras can be added to one group.





The following buttons are available on the Import Encoding Channel page:

-  **List View** View the camera in list view.
-  **Thumbnail View** View the camera in thumbnail view.

-  **Refresh** Refresh the latest information of added cameras.
-  **Import** Create a group named as *device name-Encoding Channel (Alarm Input)* and import the device to group.
-  **Collapse/Expand** Collapse/Expand the thumbnails of cameras.

8.3.3 Editing the Group/Camera

Steps:

- Select the group/camera from the group list on the Import page.
Move the mouse to the camera/group and click , or double-click the group/camera name to open Modify Group/Camera dialog box.
- Edit the group/camera information, including the group/camera name, the stream type, etc.
Video Stream: Select the stream for the live view or playback of the camera as desired.
Rotate Type: Select the rotate type for the live view or playback of the camera as desired.
Protocol Type: Select the transmission protocol for the camera.
Stream Media Server: Configure to get stream of the camera via stream media server. You can select and manage the available stream media server.
Copy to...: Copy the configured parameters to other camera(s).
Refresh: Get a new captured picture for the live view of the camera.
Note: For video stream and protocol type, the new settings will take effect after you reopen the live view of the camera.
- Click **OK** to save the new settings.
You can also double click the encoding channel on the Resource list in the Group Management interface after encoding channels encoded, or select the encoding channel and click  **Modify** to open the Modify Camera dialog box.

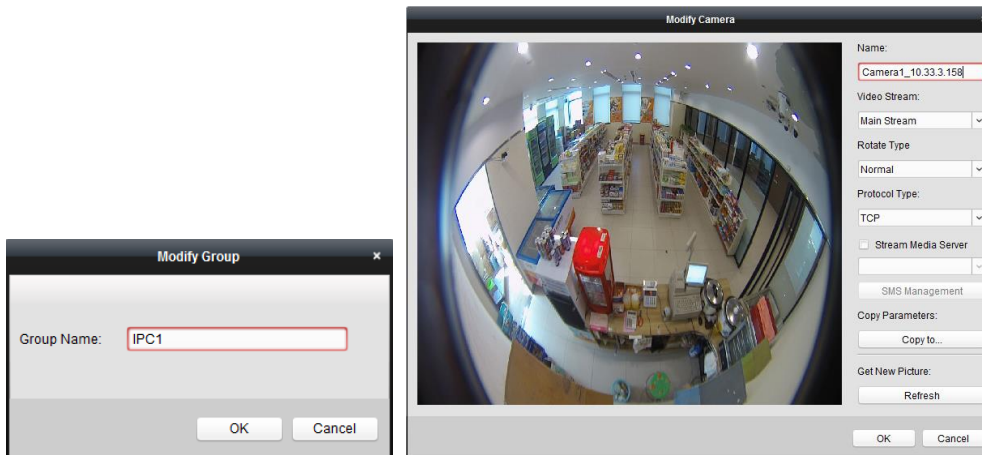

Notes:

For the IP channel of NVR which supports decoding function:

- After decoding and displaying on video wall, there will be a new channel in the Encoding Channel Resources list whose protocol type is decoding on video wall.
- After closing the corresponding roaming window, the new channel will be removed from the Encoding Channel Resources list.

8.3.4 Removing Cameras from the Group

Steps:

- Select the camera from the group list on the Import Encoding Channel page.
- Move the mouse to the camera and click  to remove the camera from the group.

You can also select the camera on the Group Management interface, and then click **Delete** to remove the camera from the group.

3. Select the group from the group list on the Import Encoding Channel page, move the mouse to the group and click  and you can remove all the cameras from the group.

8.3.5 Deleting the Group

Steps:

1. Select the group in the Group Management interface.
2. Click **Delete Group**, or move the mouse to the group and click the icon . The selected group and the resource under it will be deleted.

8.4 Live View

Purpose:

For the surveillance task, you can view the live video of the added network cameras, video encoders and video intercom device on the Main View page. And some basic operations are supported, including picture capturing, manual recording, PTZ control, etc.

Before you start:

A camera group is required to be defined for live view.

You can set the rotate type if necessary in the Group Management. For details, refer to *Modifying the Group/Camera of Chapter 8.3 Group Management*.





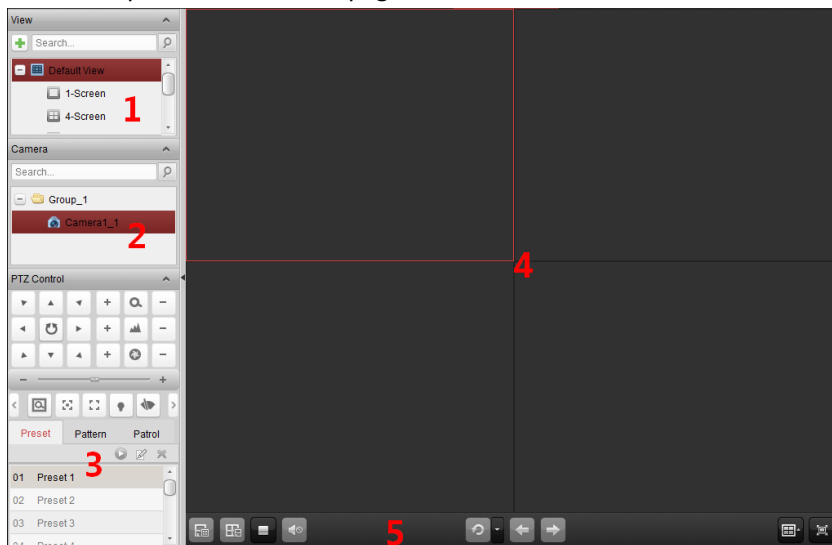

Click the  icon on the control panel, or click **View->Main View** to open the Main View page.





Main View Page

- 1 View List
- 2 Camera List
- 3 PTZ Control Panel
- 4 Display Window of Live View
- 5 Live View Toolbar

Camera Status:

-  The camera is online and works properly.
-  The camera is in live view.
-  The camera is in recording status.
-  The camera is offline.











Notes:

- If event (e.g., motion detection) is detected for the camera, the camera icon will display as  and the group icon will show as .
- If the camera is offline, the client can still get the live video via the stream media server if the stream media server is configured. The camera icon will display as .

Live View Toolbar:





















On the Main View page, the following toolbar buttons are available:



- | | | |
|-------------------------------------------------------------------------------------|---------------------------------|------------------------------------------------------------------------------------------------------------------------------------------------------------------------------------------------------------------------------------------------------------------------------------------------------------------------------------------------------------------------------------------------------------------------------------------|
|  | Save View | Save the new settings for the current view. |
|  | Save View as | Save the current view as another new view. |
|  | Stop Live View | Stop the live view of all cameras. |
|  | Mute/Audio On | Turn off/on the audio in live view |
|  | Resume/Pause Auto-switch | Click to resume/pause the auto-switch in live view. |
|  | Show/Hide the Menu | Show/Hide the configuration menu of auto-switch. Click again to hide. |
|  | Previous | Go for live view of the previous page. |
|  | Next | Go for live view of the next page. |
|  | Window Division | Set the window division. |
|  | Full Screen | Display the live view in full-screen mode.
Press Esc , or you can move the mouse to the top of the screen and click Quit Full Screen button to exit.
You can click Lock button to lock the screen, and you can click Unlock and input the client admin password to unlock it.
For full screen auto-switch, you can click Previous or Next button to view the previous or next camera. |

Right-click on the display window in live view to open the Live View Management Menu:



The following buttons are available on the right-click Live View Management Menu:

	Stop Live View	Stop the live view in the display window.
	Capture	Capture the picture in the live view process.
	Print Captured Picture	Capture the current picture and then print the picture.
	Send Email	Capture the current picture and then send an Email notification to one or more receivers. The captured picture can be attached.
	Start/Stop Recording	Start/Stop the manual recording. The video file is stored in the PC.
	Open PTZ Control	Enable PTZ control function on the display window. Click again to disable the function.
	Enable Auto-tracking	Enable the auto-tracking function of the speed dome. Then the speed dome will track the object appearing on the video automatically. This button is only available for the speed dome that supports the auto-tracking function.
	Open Digital Zoom	Enable the digital zoom function. Click again to disable the function.
	Switch to Instant Playback	Switch to instant playback mode.
	Start/Stop Two-way Audio	Click to start/stop the two-way audio with the device in live view.
	Start/Stop IP Two-way Audio	Click to start/stop the two-way audio with the camera in live view. This button is only available for the camera that supports the IP two-way audio function.
	Enable/Disable Audio	Click to enable/disable the audio in live view.
	Camera Status	Display the status of the camera in live view, including the recording status, signal status, connection number, etc.
	Remote Configuration	Open the remote configuration page of the camera in live view.
	VCA Configuration	Enter the VCA configuration interface of the device if it is VCA device.
	Synchronization	Sync the camera in live view with the PC running the client software.
	Batch Time Sync	Set time synchronization for devices in batch.
	Fisheye Expansion	Enter the fisheye expansion mode. Only available when the device is fisheye camera.

	Start/Stop Speed Dome linkage	Click to start/stop locating or tracking the target according to your demand. Only available when the device is fisheye camera. For details, please refer to <i>Chapter 2.4.8 Starting Speed Dome Linkage</i> .
	Unlock Door	Click to remote unlock the door if the device is door station, outer door station or door station (V series).
	Full Screen	Display the live view in full screen mode. Click the icon again to exit.

8.4.1 Starting and Stopping the Live View

Starting Live View for One Camera

Steps:

1. Open the Main View page.
2. Optionally, click the  icon in live view toolbar to select the window division mode for live view.
3. Click-and-drag the camera to the display window, or double-click the camera name after selecting the display window to start the live view.

Note: You can click-and-drag the video of the camera in live view to another display window if needed.

Starting Live View for Camera Group

Steps:

1. Open the Main View page.
2. Click-and-drag the group to the display window, or double-click the group name to start the live view.

Note: The display window number is self-adaptive to the camera number of the group.

Starting Live View in Default View Mode

Purpose:



The video of the added cameras can be displayed in different view modes. 4 frequently-used default view modes are selectable: 1-Screen, 4-Screen, 9-Screen and 16-Screen.

Steps:

1. Open the Main View page.
2. In the View panel, click the icon  to expand the default view list.
3. Click to select the default view mode and the video of the added cameras will be displayed in a sequence in the selected view.

Note: Click , and you can save the default view as a custom view.

Move the mouse to the view and the following icons are available:

-  **Start Instant Playback** Start the instant playback of the view.
-  **Start Auto-switch** Start switching automatically of the view.

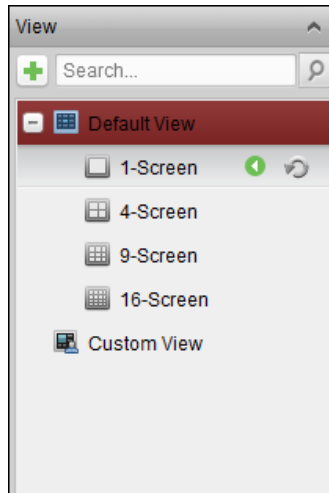

Starting Live View in Custom View Mode

Purpose:

The view mode can also be customized for the video live view.

Steps:

1. Open the Main View page.
2. In the View panel, click the icon to expand the custom view list. If there is custom view available, you can click to start live view of the custom view.
3. Click to create a new view.
4. Input the view name and click **Add**. The new view is of 4-Screen mode by default.
5. Optionally, click the icon in live view toolbar and select the screen layout mode for the new view.
6. Click-and-drag the camera/group to the display window, or double-click the camera/group name in custom view mode to start the live view.
7. Click the icon to save the new view. You can also click to save the view as another custom view.

Move the mouse to the custom view and the following icons are available:

- Edit View Name** Edit the name of the custom view.
- Delete View** Delete the custom view.
- Start Instant Playback** Start the instant playback of the view.

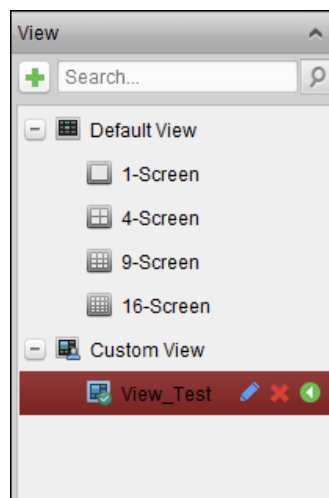

Stopping the Live View

Steps:

1. Select the display window.
2. Click the icon that appears in the upper-right corner when the mouse pointer is over the display window, or click **Stop Live View** on the right-click menu to stop the live view of the display window.
You can also click the button in live view toolbar to stop all the live view.

8.4.2 Manual Recording and Capture

Toolbar in Each Live View Display Window:



In each live view display window, the following toolbar buttons are available:

	Capture	Capture the picture in the live view process. The capture picture is stored in the PC.
	Start/Stop Recording	Start/Stop manual recording. The video file is stored in the PC.
	Switch to Instant Playback	Switch to the instant playback mode.

Manual Recording in Live View

Purpose:

Manual Recording function allows you to record the live video on the Main View page manually and the video files are stored in the local PC.

Steps:

1. Move the mouse pointer to the display window in live view to show the toolbar.
2. Click in the toolbar of the display window or on the right-click Live View Management Menu to start the manual recording. The icon turns to .
3. Click the icon to stop the manual recording.
A prompt box with the saving path of the video files you just recorded will pop up if all the operations succeed.

Notes:

- During the manual recording, an indicator appears in the upper-right corner of the display window.
- The saving path of video files can be set on the System Configuration interface. For details, see *Section 14.2.3 File Saving Path Settings*.
- For Hik Cloud P2P device, the manual recording is not supported during live view.

Viewing Local Video Files

Steps:

1. Click **File->Open Video File** to open the Video Files page.
2. Select the camera to be searched from the Camera Group list.
3. Click the icon to specify the start time and end time for the search.
4. Click **Search**. The video files recorded between the start time and end time will be displayed.
Select the video file, and click **Delete**. You can delete the video file.
Select the video file, and click **Send Email**. You can send an Email notification with the selected video file attached.
Select the video file, and click **Save as**. You can save a new copy of the video file.



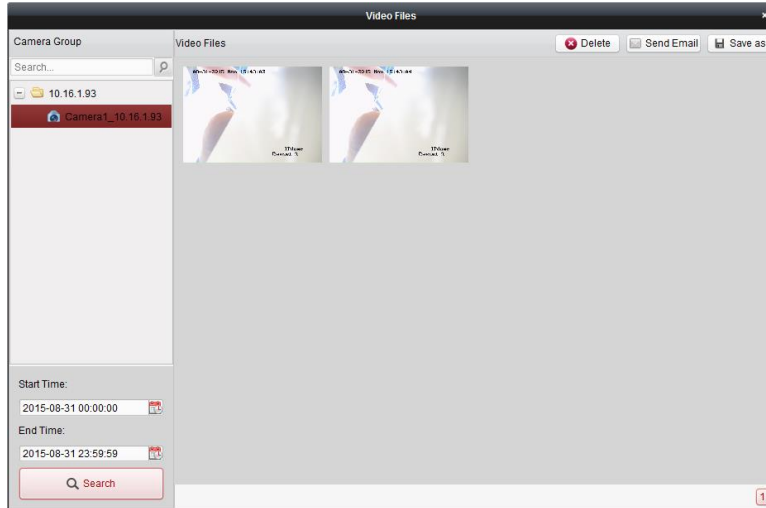









Note: To send an Email notification, the Email settings need to be configured before proceeding.



Double-click the video file and the video file can be played back locally.



The following buttons are available on the local playback page:

		CIF/4CIF	Display the video in cif/4cif resolution.
		Full Screen	Display the local playback page in full screen mode.
		Close	Close the local playback page of the video files.
		Pause/Play	Pause/Start the playback of the video files.
		Stop	Stop the playback of the video files.
		Speed	Set the playback speed.
		Single Frame	Play back the video files frame by frame.
		Digital Zoom	Enable the digital zoom function. Click again to disable.
		Enable/Disable Audio	Click to enable/disable the audio in the local playback.
		Capture	Capture the picture in the playback process.

Capturing Picture in Live View

Steps:

1. Move the mouse pointer to the display window in live view to show the toolbar.
2. Click the icon  in the toolbar of the display window or on the right-click Live View Management Menu.
A small window of the captured picture will be displayed to notify whether the capturing operation is done or not.

Note: The saving path of the captured pictures can be set on the System Configuration interface. For details, see *Section 14.2.3 File Saving Path Settings*.

Viewing Captured Pictures

The pictures captured in live view are stored in the PC running the software. You can view the captured pictures if needed.

Steps:

1. Click **File->Open Image File** to open the Captured Images page.
2. Select the camera to be searched from the Camera Group list.
3. Click the icon  to specify the start time and end time for the search.
4. Click **Search**. The pictures captured between the start time and end time will be displayed.
5. Double-click the captured picture to enlarge it for a better view.

Select the captured picture, and click **Print**. You can print the selected picture.

Select the captured picture, and click **Delete**. You can delete the selected picture.

Select the captured picture, and click **Send Email**. You can send an Email notification with the selected picture attached.

Select the captured picture, and click **Save as**. You can save a new copy of the selected picture.

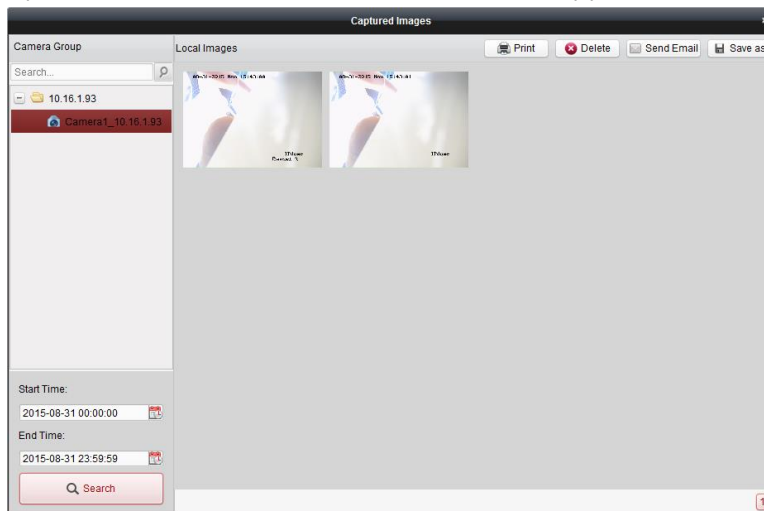

8.4.3 Instant Playback



Purpose:

The video files can be played back instantly on the Main View page. Instant playback shows a piece of the video which was remarkable, or which was unclear on the first sight. Thus, you can get an immediate review if needed.

Before you start:

The video files need to be recorded on the storage devices, such as the SD/SDHC cards and HDDs on the DVRs, NVRs, Network Cameras, etc., or on the storage servers.

Steps:

1. Start the live view and move the mouse to the display window to show the toolbar. You can also move the mouse to default view or custom view and click  to enable the instant playback of the selected view.
2. Click the icon  in the toolbar and a list of time periods pops up.
30s, 1 min, 3 min, 5 min, 8 min, and 10 min are selectable.

3. Select a time period to start the instant playback.





Example: If the current time of the live view is 09:30:00, and you select 3 min, then the instant playback will start from 09:27:00.

4. Click the icon  again to stop the instant playback and go back for the live view.

Note: During the instant playback, an indicator  appears in the upper-right corner of the display window.







On the instant playback page, the following toolbar buttons are available:

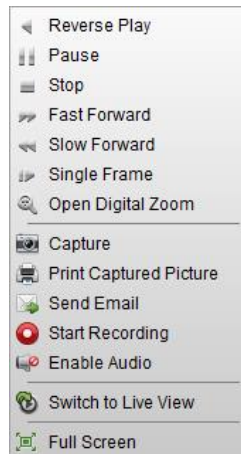







	Reverse Playback	Play back the video file reversely.
	Pause/Start Playback	Pause/Start the playback of the video files.
	Stop Playback	Stop the playback of all cameras.
	Slow Forward/Fast Forward	Decrease/Increase the play speed of the playback.
	Single Frame (Reverse)	Play back the video files frame by frame (reversely).

Right-click on the display window to open the Instant Playback Management Menu:



The following buttons are available on the right-click Instant Playback Management Menu:

	Reverse Playback	Play back the video file reversely.
	Pause/Play	Pause/Start the instant playback in the display window.
	Stop	Stop the instant playback and return to the live view mode.
	Fast Forward/Slow Forward	Increase/Decrease the play speed of the instant playback.

	Single Frame (Reverse)	Play back the video file frame by frame (reversely).
	Open Digital Zoom	Enable the digital zoom function. Click again to disable the function.
	Capture	Capture the picture in the instant playback process.
	Print Captured Picture	Capture the current picture and then print the picture.
	Send Email	Capture the current picture and then send an Email notification to one or more receivers. The captured picture can be attached.
	Start/Stop Recording	Start/Stop clipping the video files.
	Enable/Disable Audio	Click to turn on/off the audio in instant playback.
	Switch to Live View	Switch to live view mode.
	Full Screen	Display the instant playback in full screen mode. Click again to exit.

8.4.4 Custom Window Division

Purpose:

The client software provides multiple kinds of pre-defined window division. You can also set custom window division as desired.

Steps:

1. Click  on the live view toolbar and select  to pop up the custom window division dialog box.

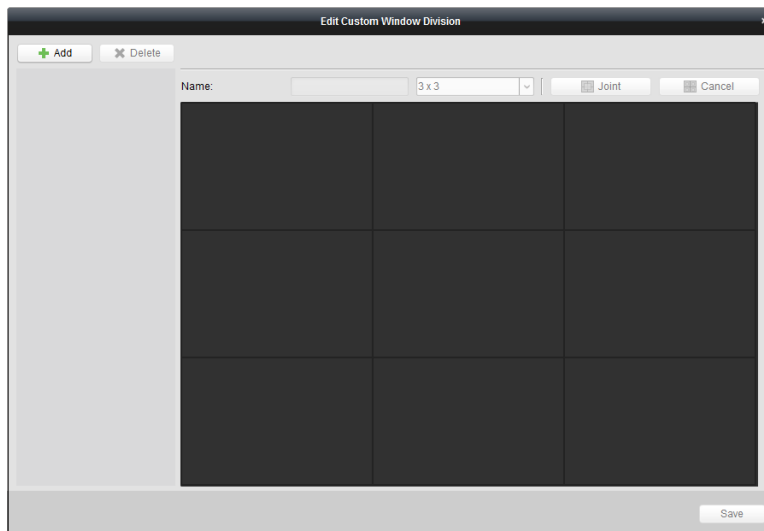

2. Click **Add** to open the custom window division adding dialog box.
Note: Up to 5 custom window divisions can be added.
3. Set a name for the new window division as desired and click **OK** to save the settings.

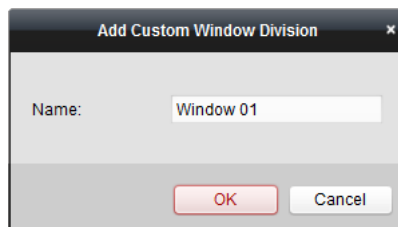

4. You can edit the name, window division (3x3, 4x4, 5x5) for it.
5. Click-and-drag you mouse to select the adjacent windows, and click **Joint** to joint them as a whole window. You can also click **Cancel** to cancel the jointing.

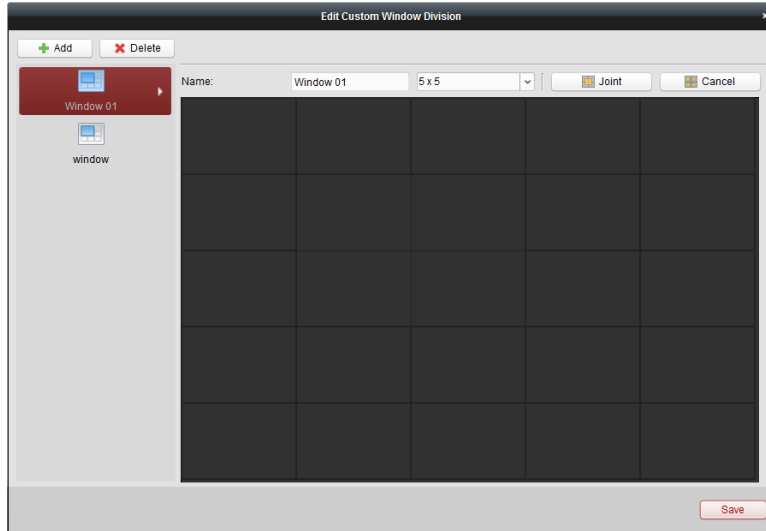

6. Click **Save** to confirm the settings. Click to back to the Main View page. Then you can click and select the custom window division for playing live video.

Notes:

- You can also enter the Remote Playback page and perform the steps above to configure the custom window division.
- For remote playback, up to 16 windows can be played back at the same time. The custom window division with more than 16 windows is invalid for playback.

8.4.5 Other Functions in Live View

There are some other functions supported in the live view, including digital zoom, two-way audio, camera status and synchronization.

Auxiliary Screen Preview

The live video can be displayed on different auxiliary screens for the convenient preview of multiple monitoring scenes. Up to 3 auxiliary screens are supported.

Channel-zero

For the channel-zero of the device, you can hold the *Ctrl* key and double-click to display the specific channel. Hold the *Ctrl* key and double-click again to restore.

Two-way Audio

Two-way audio function enables the voice talk of the camera. You can get not only the live video but also the real-time audio from the camera. If the device has multiple two-way audio channels, you can select the channel to start two-way audio.

The two-way audio can be used for only one camera at one time.

Camera Status

The camera status, such as recording status, signal status, connection number, etc., can be detected and displayed for check. The status information refreshes every 10 seconds.

Synchronization

The synchronization function provides a way to synchronize the device clock with the PC which runs the client software.

8.5 Playback

When the video storage devices are the HDDs, Net HDDs, SD/SDHC cards on the local device, or the remote storage server connected, you can set the recording schedule or capture schedule for the cameras for the continuous, alarm triggered or command triggered recording or capture. And the video files can be searched for the remote playback.

8.5.1 Storing on Storage Device

Purpose:

You can add storage device to the client for storing the video files and pictures of the added encoding devices and you can search the files for remote playback. The storage device can be storage server, CVR (Center Video Recorder) or other NVR. Here we take the settings of storage server as an example.

Before you start:

The storage server application software needs to be installed and it is packed in the iVMS-4200 software package. When installing the iVMS-4200, check the checkbox **Storage Server** to enable the installation of storage server.

Adding the Storage Server

Steps:

1. Click the shortcut icon  on the desktop to run the storage server.

Notes:

- You can also record the video files on the storage server installed on other PC.
- If the storage server port (value: 8000) is occupied by other service, a dialog box will pop up. You should change the port No. to other value to ensure the proper running of the storage server.

2. Open the Device Management page and click the **Server** tab.
3. Click **Add New Device Type**, select **Storage Server** and click **OK**.
4. Click **Storage Server** on the list to enter the Storage Server Adding interface.

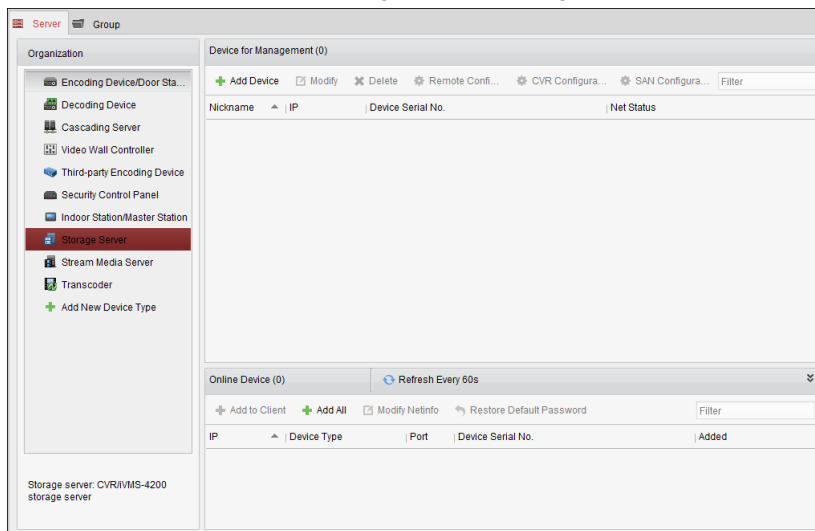

5. Add the storage server.

Formatting the HDDs

The HDDs of the storage server need to be formatted for the video file and picture storage.

Steps:

1. Select the added storage server from the list and click **Remote Configuration**.
2. Click **Storage->General**, to enter the HDD Formatting interface.

- Select the HDD from the list and click **Format**. You can check the formatting process from the process bar and the status of the formatted HDD changes from *Unformatted* to *Normal Status*.

Note: Formatting the HDDs is to pre-allocate the disk space for storage and the original data of the formatted HDDs will not be deleted.

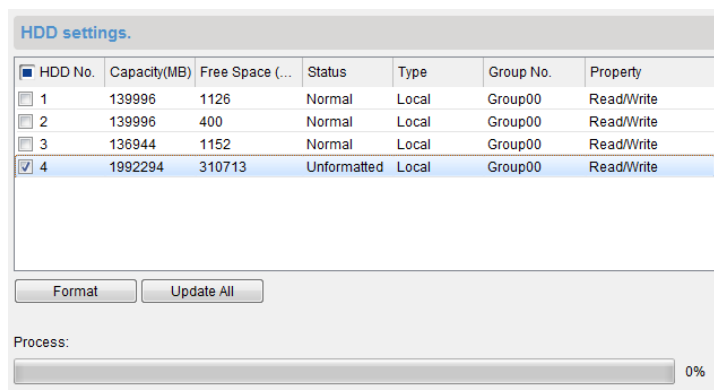

SAN and CVR Configuration

Purpose:

Client provides SAN configuration and CVR configuration to conveniently set the logical volume and CVR function for CVR device. For detailed introduction about SAN configuration and CVR configuration, refer to the *User Manual* of the CVR.

Note: This function should be supported by the device.

Select the added CVR from the list and click **CVR Configuration** or **SAN Configuration**.

Configuring Storage Schedule

Before you start:

The storage server needs to be added to the client software and the HDDs need to be formatted for the video file storage.

Steps:

- Open the Storage Schedule page.
- Select the camera from the Camera Group list.
- Select the storage server from the **Storage Server** drop-down list.

Note: You can click **Storage Server Management** to add, edit or delete the storage server.

- Check the checkbox **Recording Schedule** to enable storing the video files.

You can also check the checkbox **Picture Storage** to store the alarm pictures of the camera when event occurs.

For the network cameras with the function of heat map or people counting, the **Additional Information Storage** checkbox is available. You can click **VCA Config** to set the VCA rule for the camera, and check the **Additional Information Storage** checkbox and the heat map, people counting data and road traffic data will be uploaded to the storage server.

Note: For detailed configuration about setting the VCA rule, please refer to the *User Manual* of the camera.

- Select the schedule template for recording from the drop-down list.
If you need to edit or customize the template, see *Configuring Recording Schedule Template*.
- Click **Advanced Settings** to set the pre-record time, post-record time and other parameters for recording.
- Click **Set Quota** to enter the HDD management interface of the storage server. You can set the corresponding quota ratio for record, picture and additional information.

Example: If you set the record quota as 60%, then the 60% of the storage space can be used for storing the video files.

8. Click **Save** to save the settings.

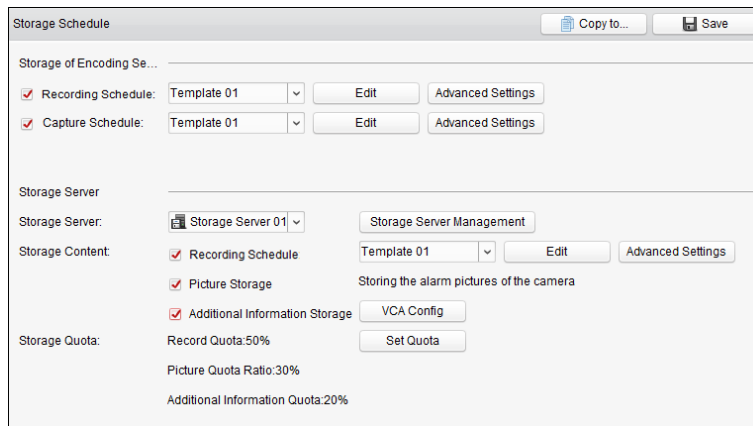

Note: The storage server supports storage of line crossing detection alarm, intrusion detection alarm, region entrance detection alarm, region exiting detection alarm, fast moving detection alarm, people gathering detection alarm, loitering detection alarm, parking detection alarm, object removal detection alarm, and unattended baggage detection alarm recording. For details, refer to *Chapter 8.5.3 Event Management*.

8.5.2 Normal Playback

Purpose:

The video files stored on the local device or the storage server can be searched by camera or triggering event, and then can be played back remotely.

Before you start:

You can set to play back the video files stored in the local device, in the storage server, or both in the storage server and local device. For details, refer to *8.5.1 Storing on Storage Device*.

Optionally, you can set the cameras rotate direction for playback in Group Management. Refer to *Editing the Group/Camera of Chapter 8.3 Group Management*.



Click the icon on the control panel, or click **View->Remote Playback** to open the Remote Playback page.

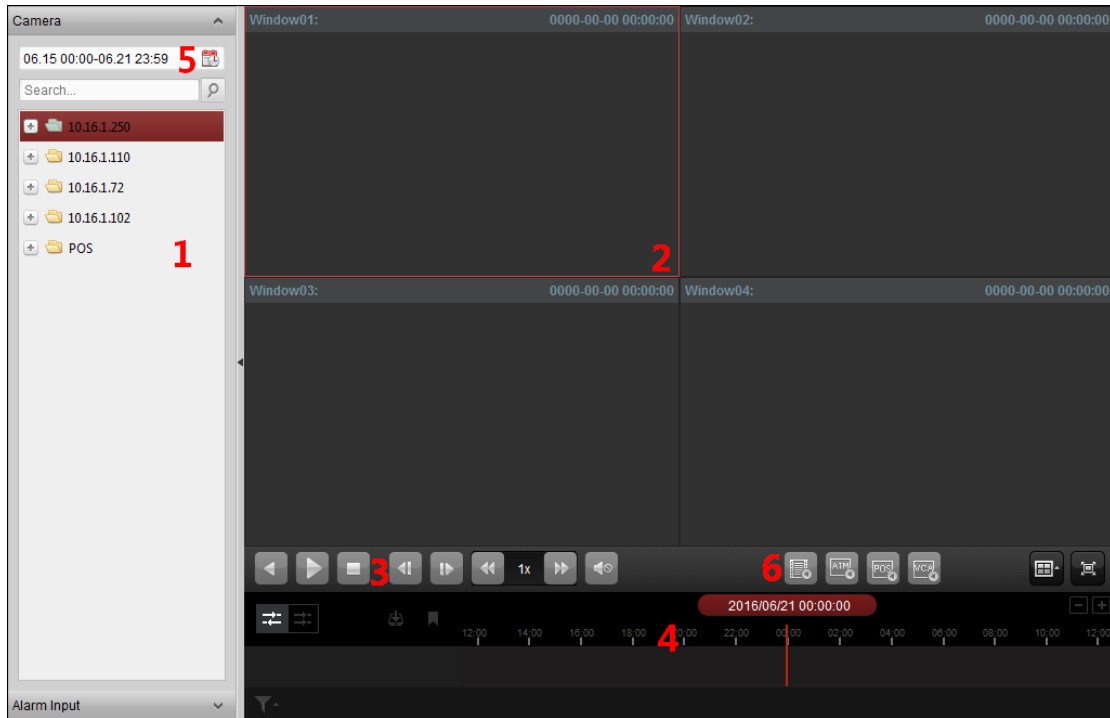

Remote Playback Page

- 1 Camera List
- 2 Display Window of Playback
- 3 Playback Control Buttons
- 4 Timeline
- 5 Calendars
- 6 Search Condition

Switching Video Stream for Playback

Purpose:

Optionally, you can switch between main stream and sub-stream for playback.

Before you start:

Set the video stream for recording as Dual-Stream.

Note: This function should be support by the device.

Steps:

1. Enter Group Management interface and open the Modify Camera dialog (refer to *Editing the Group/Camera of Chapter 8.3 Group Management*).
2. Set the video stream of the camera to main stream or sub-stream.

Searching Video Files for Normal Playback

Steps:

1. Open the Remote Playback page.
2. Click the calendars icon  to activate the calendars dialog. Select the start and end date and set the accurate time. Click **OK** to save the searching period.
3. Click-and-drag the camera or group to the display window, or double-click the camera or group to start the playback.

4. The found video files of the selected group or camera will be displayed on the right of the interface in chronological order. You can filter the results through the **Filter** text field. The first video file will be played back automatically by default.

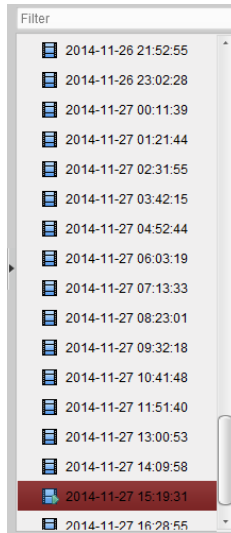

Notes:

- Up to 16 cameras can be searched simultaneously.
- In the calendar, the date which has scheduled records will be marked with ▲ and the date with event records will be marked with ▲.

Playing Back Video Files

After searching the video files for the normal playback, you can play back the video files in the following two ways:

● **Playback by File List**

Select the video file from the search result list, and then click the icon ▶ on the video file, or double-click the video file to play the video on the display window of playback.

You can also select a display window and click the icon ▶ in the toolbar to play back the corresponding video file.

● **Playback by Timeline**

The timeline indicates the time duration for the video file, and the video files of different types are color coded. Click on the timeline to play back the video of the specific time.

You can click + or - to scale up or scale down the timeline bar.

You can drag the timeline bar to go to the previous or the next time period.



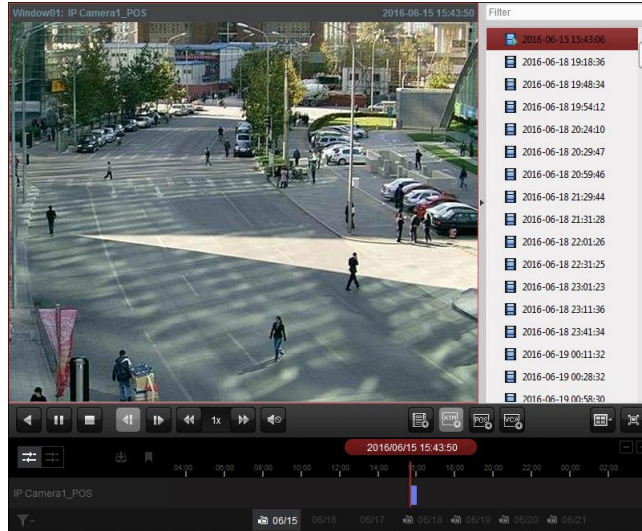



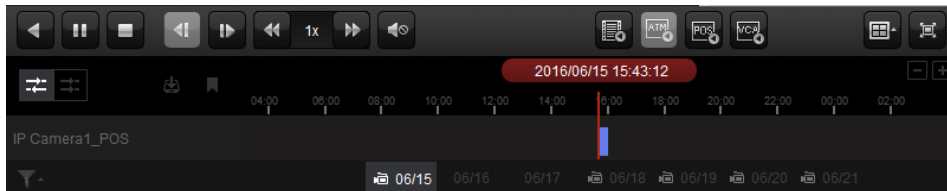









You can use the mouse wheel to zoom in or zoom out on the timeline.







Normal Playback Toolbar:



On the Normal Playback page, the following toolbar buttons are available:







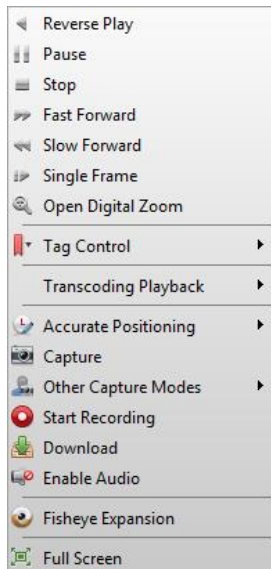





- | | | |
|-------------------------------------------------------------------------------------|----------------------------------|-----------------------------------------------------------------------------------------------------------------------------------------------|
|  | Reverse Playback | Play back the video file reversely. |
|  | Pause/Start Playback | Pause/Start the playback of the video files. |
|  | Stop Playback | Stop the playback of all cameras. |
|  | Single Frame (Reverse) | Play back the video files frame by frame reversely. You can also scroll down the mouse wheel to play the video file frame by frame reversely. |
|  | Single Frame | Play back the video files frame by frame. You can also scroll down the mouse wheel to play the video file frame by frame. |
|  | Slow Forward/Fast Forward | Decrease/Increase the play speed of the playback. |
|  | Volume | Click to turn on/off the audio and adjust the audio volume. |
|  | Event Playback | Search the recordings triggered by event, such as motion detection, video loss or video tampering. |
|  | ATM Playback | Search the recordings of ATM devices. |
|  | POS Playback | Search the recordings which contain POS information. |
|  | VCA Playback | Set the VCA rule to the searched video files that VCA event occurs, including VCA Search, Intrusion and Line Crossing. |
|  | Window Division | Set the window division. |
|  | Full Screen | Display the video playback in full-screen mode. Press ESC to exit. |
|  | Async/Sync Playback | Click to play back the video files synchronously/asynchronously. |
|  | Download | Download the video files of the camera and the video files are stored in the PC. You can select to download by file, by date, or by tag. |
|  | Tag | Add default tag for the video file to mark the important video point. |



-  **Filter** You can edit the tag or go to the tag position via the right-click menu. Display the record types as desired. E.g., you can select to display only the event recording.
-  **Accurate Positioning** Set the accurate time point to play back the video file.
-  **Date** The day that has video files will be marked with .

Right-click on the display window in playback to open the Playback Management Menu:



The following items are available on the right-click Playback Management Menu:

-  **Reverse Playback** Play back the video file reversely.
-  **Pause/Start** Pause/Start the playback.
-  **Stop** Stop the playback.
-  **Fast Forward** Play back the video file at a faster speed.
-  **Slow Forward** Play back the video file at a slower speed.
-  **Single Frame (Reverse)** Play back the video file frame by frame (reversely).
-  **Open Digital Zoom** Enable the digital zoom function. Click again to disable the function.
-  **Tag Control** Add default (default tag name *TAG*) or custom tag (customized tag name) for the video file to mark the important video point. You can also edit the tag or go to the tag position conveniently.
-  **Accurate Positioning** Set the accurate time point to play back the video file.
-  **Capture** Capture the picture in the playback process.
Print Captured Picture: Capture a picture and print it.
Send Email: Capture the current picture and then send an Email notification to one or more receivers. The captured picture can be attached.
Custom Capture: Capture the current picture. You can edit its name and then save it.
-  **Other Capture Modes**
-  **Start/Stop Recording** Start/Stop the manual recording. The video file is stored in the PC.
-  **Download** Download the video files of the camera and the video files are stored in

-  **Enable/Disable Audio** Click to enable/disable the audio in playback.
-  **Fisheye Expansion** Enter the fisheye playback mode.
-  **Full Screen** Display the playback in full-screen mode. Click the icon again or press *Esc* key to exit.

Downloading Video Files

During playback, you can click  on the toolbar to download the video files of the camera to the local PC. You can select to download by file, by date, or by tag.

Download by Files

Steps:

1. Click **Download by Files** tab in the File Download interface. You can view the video files information of selected camera.
2. Check the checkbox of the video file and the total size of the selected files will be shown below.
3. Click **Download** to start downloading the file to the local PC.

You can input the flow (0 to 32768 kbps) and click **Set** to control the downloading speed.

4. Optionally, you can click **Stop** to stop downloading manually.

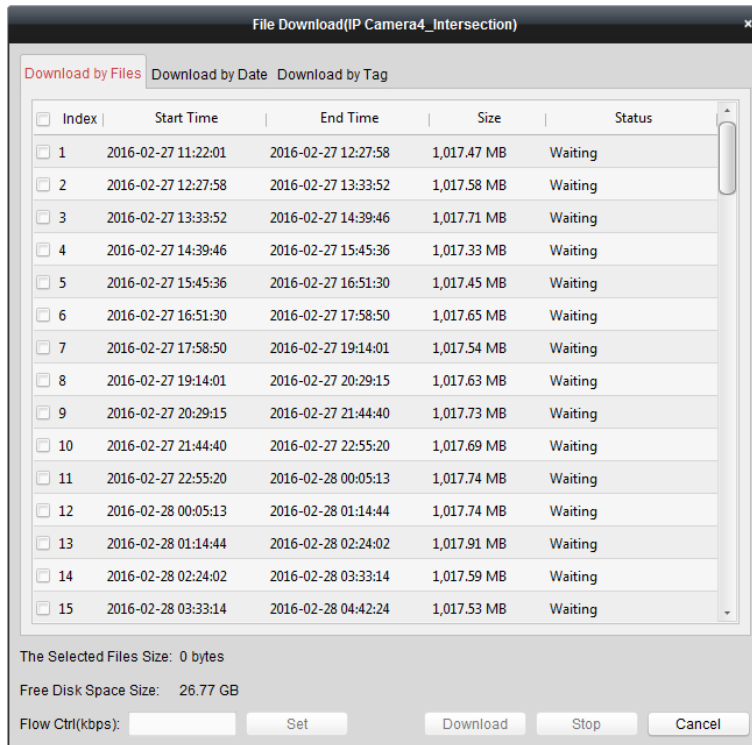

Download by Date

Steps:

1. Click **Download by Date** tab in the File Download interface.
2. Check the checkbox of the time duration to enable it, and click  to set the start and end time.
3. Click **Download** to start downloading the file to the local PC. The progress bar shows the downloading process.

You can input the flow (0 to 32768 kbps) and click **Set** to control the downloading speed.

4. Optionally, you can click **Stop** to stop downloading manually.

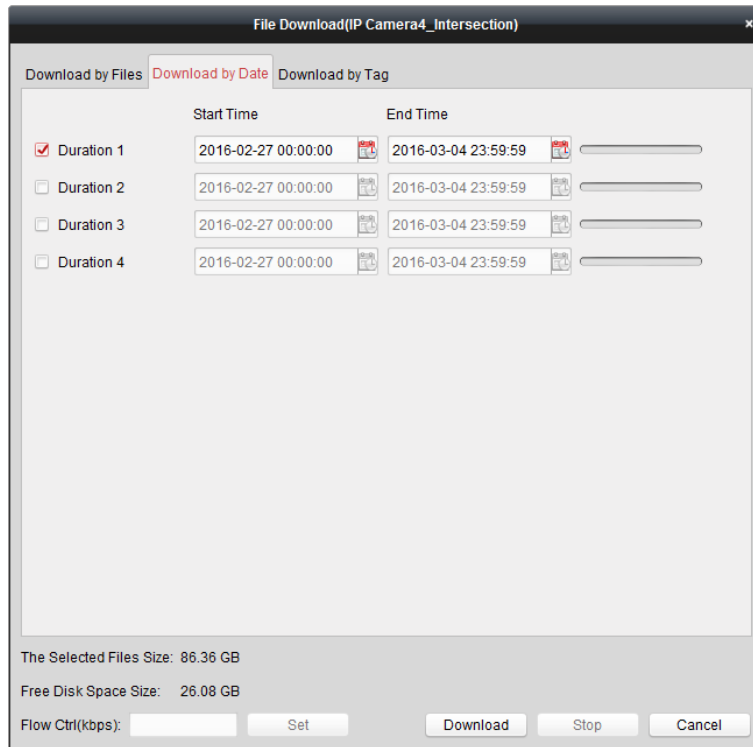

Note: When downloading video file of one time duration, you can set to merge the video files. The video files in the set time duration can be merged for downloading. For configuring merging downloaded video files, refer to [8.2 Live View and Playback Settings](#).

Download by Tag

Steps:

1. Click **Download by Tag** tab in the File Download interface. The added tags will be displayed.
2. Check the checkbox of the tag and the total size of the selected files will be shown below.
3. Click **Download** to start downloading the selected file (30 seconds before the selected tag to 30 seconds after the tag) to the local PC. You can input the flow (0 to 32768 kbps) and click **Set** to control the downloading speed.
4. Optionally, you can click **Stop** to stop downloading manually.

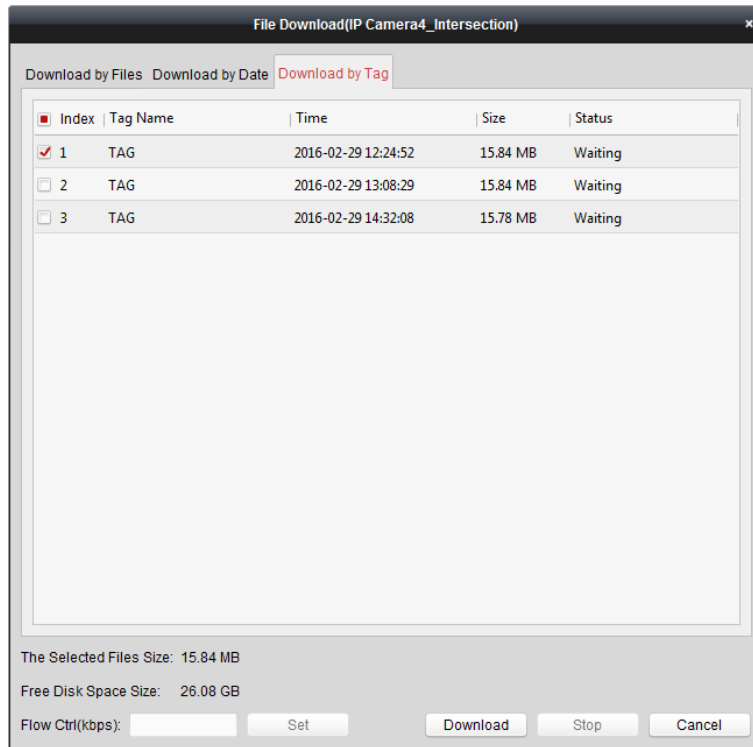



8.5.3 Event Playback

Purpose:

The recordings triggered by event, such as motion detection, VCA detection or behavior analysis, can be searched for Event Playback and this function requires the support of the connected device.



Searching Video Files for Event Playback



Steps:

1. Open the Remote Playback page.
2. Select the camera and start the normal playback. Refer to *Chapter 8.5.2 Normal Playback*.
3. Click  and the motion detection triggered recording will be searched by default.
4. Click the calendars icon  to activate the calendars dialog box.

Select the start and end date and set the accurate time.

Click **OK** to save the searching period.

Note: In the calendar, the date which has scheduled records will be marked with  and the date with event records will be marked with .

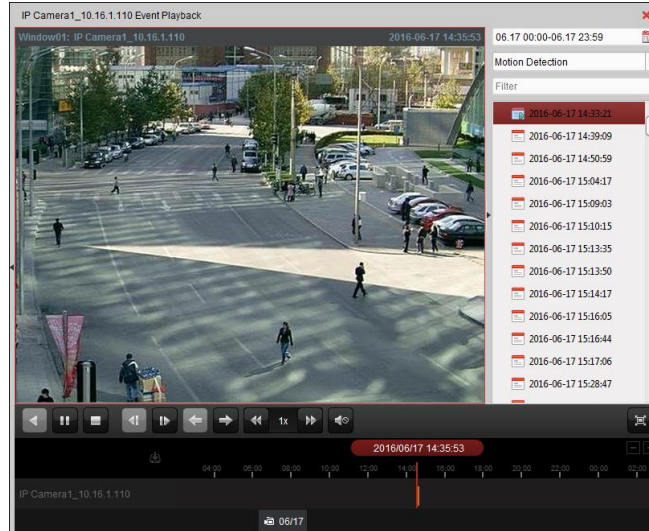

5. Select the event type from the drop-down list and the found video files will be displayed. You can filter the results by inputting the keyword in the **Filter** text field. Or you can click  to go back to the normal playback.
6. Select the video file from the search result list, and then click the icon  on the video file, or double-click the video file to play the video on the corresponding display window of playback.



Playing Back Video Files



After searching the recordings triggered by the event, you can play back the video files in the following two ways:

- **Playback by File List**

Select the video file from the search result list, and then click the icon  in the toolbar, or click the icon  on the video file, or double-click the video file to play the video on the corresponding display window of playback.

- **Playback by Timeline**

The timeline indicates the time duration for the video file. Click on the timeline to play back the video of the specific time.

You can click  or  to scale up or scale down the timeline bar.







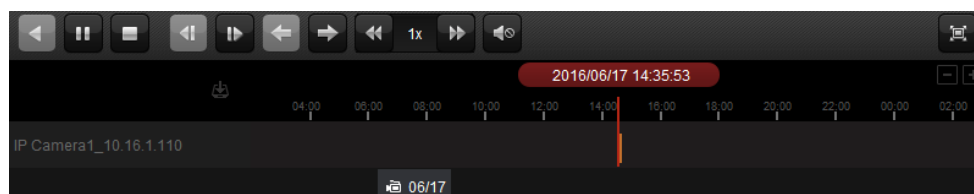



You can drag the timeline bar to go to the previous or the next time period.

You can use the mouse wheel to zoom in or zoom out on the timeline.

Event Playback Toolbar:



On the Remote Playback page, the following toolbar buttons are available:

	Reverse Playback	Play back the video file reversely.
	Pause/Start Playback	Pause/Start the playback of the video files.
	Stop Playback	Stop the playback of all cameras.
	Single Frame (Reverse)	Play back the video files frame by frame reversely.
	Single Frame	Play back the video files frame by frame.
	Previous Event	Go to the playback of the previous event.
	Next Event	Go to the playback of the next event.
	Slow Forward/Fast Forward	Decrease/Increase the play speed of the playback.
	Volume	Click to turn on/off the audio and adjust the audio volume.
	Full Screen	Display the video playback in full screen mode. Press ESC to exit.



Download

Download the video files of the camera and the video files are stored in the PC.



Accurate Positioning

Set the accurate time point to play back the video file.



Date

The day that has video files will be marked with .

Please refer to *Chapter 8.4.2 Normal Playback* for the description of the right-click menu. Some icons may not be available for event playback.

Note: You can set the pre-play time for event playback in System Configuration. By default, it is 30s. For configuring the pre-play time, refer to *Live View and Playback Settings* in 8.5.3 Event Playback.

9 Appendix

9.1 DIP Switch Introduction

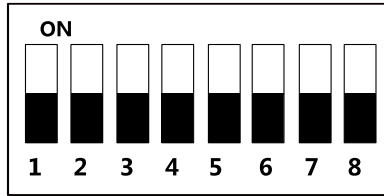

Figure 9-1 DIP Switch Module

Table 9-1 Description of DIP Switch

Icon	Description
	Represent 1 in binary mode
	Represent 0 in binary mode

For example, binary value of the following status is: 0000 1100.

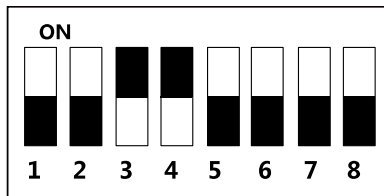

Figure 9-2 DIP Switch Module

Table 9-2 Description of DIP Switch

No.	Description	DIP Switch Status
1 ~ 4	Address of RS-485	2: Security Module 0: Card Reader
5	RS-485 Direction under the Terminal Mode	1: Upstream; 0: Down Stream
6	Working Method	1: Card Reader; 0: Terminal.
7	Wiegand Protocol (available when No. 6 is 1)	1: Wiegand protocol of 26-bit; 0: Wiegand protocol of 34-bit.
8	Matched Resistance (available for RS-485 protocol)	1: Enable; 0: Disable.

9.2 Indicator and Buzzer Description

Power on after 10s, the buzzer will beep once. When the device is powered on, the buzzer will beep again (once). The indicator will remain red in this duration.

The buzzer descriptions are as follows:

Type	Description
Beep Once	Card Swiping
	Pressing Button
Fast Beep Twice	Valid Card Swiping
Slow Beep for Three Times	Invalid Card Swiping
Rapid and Continuous Beep	Tampering Alarm
	Buzzer Alarm
Slow and Continuous Beep	Not Encrypted Card Reader

The card reader indicator descriptions are as follows:

Indicator	Description
Flashing Green Once and Flashing Red for 3 Times	Powering On
Solid Green for 3s	Multiple Authentications
Solid Red	Working Properly
Flashing Red for 3 Times	Invalid Card Swiping
Continuous Flashing Red	Card Reader Mode Offline and Registration Failure

9.3 Access Controller Model List

The available access controller models are as follows:

Model
DS-K2601
DS-K2602
DS-K2604
DS-K2601-G
DS-K2602-G
DS-K2604-G
DS-GJZA6201
DS-GJZA6202
DS-GJZA6204
DS-K2110-DK
DS-K2110-2DK
DS-K2110-4DK
DS-K1T200EF/MF/CF
DS-K1T200EF/MF/CF-C
DS-K1T300EF/MF/CF
DS-K1T300EF/MF/CF-C
DS-K1T105E/M/C
DS-K1T105E/M/C-C
DS-K1T501SF
DS-K1T500S

010100001090312



See Far, Go Further